



WireCAD v6.1 User Manual

© 2010 Holbrook Enterprises, Inc. dba WireCAD

Introducing WireCAD v6

by Holbrook Enterprises, Inc. dba WireCAD

WireCAD v6.1 User Manual

© 2010 Holbrook Enterprises, Inc. dba WireCAD

All rights reserved. You may copy or graphically reproduce this work for your own use, provided that no part of this work is reproduced in any form or by any means - graphic, electronic, or mechanical, including photocopying, recording, taping, or information storage and retrieval systems for profit - without the written permission of the publisher.

Products that are referred to in this document may be either trademarks and/or registered trademarks of the respective owners. The publisher and the author make no claim to these trademarks.

While every precaution has been taken in the preparation of this document, the publisher and the author assume no responsibility for errors or omissions, or for damages resulting from the use of information contained in this document or from the use of programs and source code that may accompany it. In no event shall the publisher and the author be liable for any loss of profit or any other commercial damage caused or alleged to have been caused directly or indirectly by this document.

Printed: December 2010

Publisher

*Holbrook Enterprises, Inc.
dba WireCAD*

Special thanks to:

All the people who contributed to this document, to Lisa for being a WireCAD widow. And the kids for being willing to start over in Idaho.

Thanks to Tara for handling the details.

Thanks to the Sales and Support teams.

To Tim and Barb for their excellent support.

And a very special thanks to all of you WireCAD users, and you know who you are, that help to make the program better!

*Christian Holbrook
President*

Table of Contents

Foreword	1
Part I Introduction	3
1 New in 6.1	4
2 Software Activation	5
3 License Agreement	9
4 Licensing FAQ	11
Part II Getting Started	14
1 Setting Up Your Global Data	16
2 Equipment Library	17
Creating a New Equipment Definition	19
Adding Equipment to Drawings	20
3 Creating a New Project	22
4 Creating a New Drawing	23
5 Drawing Cables	24
6 Assigning Unique IDs (SysNames)	36
7 Assigning Cable Numbers	38
8 Assigning Terminals	39
9 Rack Builder Tool	41
10 AutoScheme Tools	45
Auto Block	46
RatsNest	47
11 System Snapshot	47
Part III Personalizing WireCAD	50
1 The Settings Dialog	50
2 Setting the Skin	60
3 Template Drawings	62
Part IV Reporting	65
1 Printing Reports	65
2 Filtering Reports	66
3 Creating Reports	68
Standard	68
Labels	72
Report Design Basics	76
Part V Advanced Topics	79
1 SysName Formatting	79

2 Cable Number Formatting	81
Part VI Frequently Asked Questions	86
1 Placing Custom Titleblocks (Page Borders)	86
2 Creating Custom Titleblocks	87
3 Moving Projects (Pack Up/Check-Out)	88
4 Synchronizing with Another Equipment Database	91
5 Setting Up On a Network	93
6 Upgrading from v5	93
Part VII Choosing a Database Format	97
1 SQL Server Setup	98
Part VIII Included Plugins	101
1 Pinouts	101
2 Search	102
3 Translation Manager	102
4 Block Extractor	103
5 Bulk Block Fixer	104
6 DWG Diff	107
Introduction	107
Screen Shots.....	107
Functions.....	109
7 Brother P-Touch	110
Introduction	110
Data Page.....	111
Print Cable Labels and Port Tags.....	112
Database Field Rules	114
Cable Number Fields.....	115
SysName Fields.....	116
More about the .LBL file	117
Part IX CAD Basics	119
1 What is CAD ?	119
2 Drawing Entities	120
Line	120
Circle	121
Polyline	122
Arc	125
Dimension	125
Image	126
Polyface	127
PolyHatch	127
Ellipse	127
Text	128
Insert	129
3DFace	129

3 Collections	130
Layers	130
Layouts	132
TextStyles	133
DimStyles	133
Blocks	134
Lights	135
Selections	135
Section Clips	135
Linetypes	136
Lineweights	137
4 Commands	137
Select	138
Erase	138
Undo	139
Copy	139
Offset	139
Fillet	140
Move	141
Trim	141
Extend	141
Mirror	142
Array	142
Break	143
Scale	143
Explode	144
Purge	144
Zoom	144
Pan	145
View3D	145
5 Limits	146
6 Coordinates	146
7 Viewport	147
8 Model Space Boundaries	148
9 Grid	149
10 Snap	150
11 Ortho	150
12 Osnap	150
13 Units	151
14 Print	151
15 PDF Export	152
16 Extrusion Vector	153
Part X Customizing WireCAD (SDK)	156
1 Hello World	157
2 Getting Started	160
3 Registering Your Plugin	162

Index

166

Foreword

This manual is a work in progress. While you are viewing the printed version, the online documentation is updated with every revision and hotfix. Be sure to visit www.wirecad.com for the latest documentation.

Part

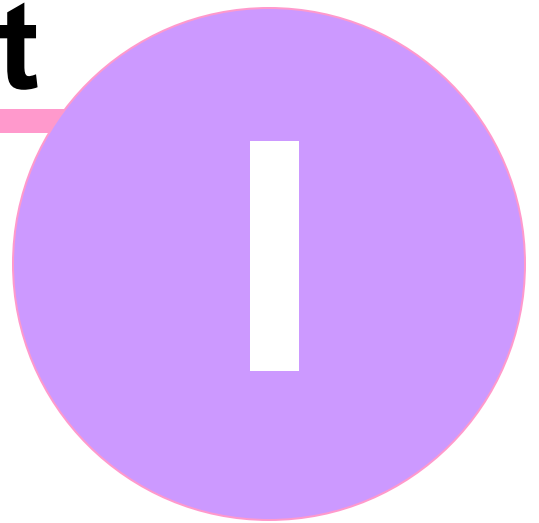

1 Introduction

Welcome to WireCAD. WireCAD tools aim to decrease the frustration associated with creating accurate, detailed documentation. WireCAD produces DWG compatible drawings.

What is WireCAD?

WireCAD is a cable management and facility design tool that allows you to easily create AutoCAD™ drawings. WireCAD maintains a database of equipment, from which you can create equipment blocks for your drawings. Equipment blocks are created dynamically from information stored in the equipment database. Rather than maintaining a large library of equipment blocks or symbols, WireCAD stores this information in a database and then creates blocks from the equipment definitions contained therein. Equipment definitions are easily added to the database. In addition to equipment databases, WireCAD also provides drawing tools to rapidly create documentation, and database management tools to track:

- Projects
- Drawings
- Revisions
- Cable Types
- Signal Types
- Connectors
- Jack Fields
- Jacks

The biggest time saver comes when it is time to assign System Names and Cable Numbers to the equipment in your drawing. All you do is double-click on the equipment pieces in the drawing to assign them a system name. Then double-click on the cable and assign it a cable number. All of the information regarding the selected cable is extracted from the drawing and placed in the project cables database and the drawing is updated with a new cable number.

Extensive reporting is available for the project databases including:

- Project drawings
- Project revisions
- Cable run sheets
- Cable labels
- Equipment lists
- Bill of Materials

In addition, a powerful report designer is included with WireCAD for creating your own reports and labels, or modifying existing report definition files.

Contents

[New in 6.1](#) ⁴
[Software Activation](#) ⁵
[License Agreement](#) ¹¹
[Licensing FAQ](#) ¹¹

1.1 New in 6.1

The short list of feature additions and changes in the current release:

Features:

- Polygon [viewports](#)^[147] and boundaries. This allows you to create custom shaped viewports.
- Auto-aligning [boundaries](#)^[148]. No more zooming to scale and then positioning the viewport manually.
- Re reference pointers function. Changes the SheetReference on pointers in the current drawing or project wide.
- Drawing error check still beta. Checks the drawing against the database and shows the error list in grid form.
- Slurp SysNames. Pulls all SysNames from a drawing and puts them in the systems database. Cool for reusing drawing from other projects
- Improved [Settings](#)^[50] dialog. Lots of improvements to the settings dialog including the ability for plugin developers to register their own settings panels.
- Modifications to [Terminal Assignment](#)^[40]. Now very easy to change the SysName of a terminal and keep port data unchanged.
- DWG 2010. Now supports reading ACAD 2010.
- Fixes to HP plotters. Fixes an issue that made plotting to HP plotters difficult.
- Works with VBox. Now works with oracle VBox virtual machines.
- Flipped pointer sets that work backwards in a drawing. This is useful if you need to represent a cable in the drawing from right-to-left using pointers.
- [Port Polling](#)^[55] Status Bar Panel. When drawing a cable shows the port info (Name, Type, Connector) in the status bar panel. Helps to reduce confusion.
- Text Editor. Works with both Text and Mtext entities.
- Assign Cable After Draw. When checked, and cable draw is completed the Assign Cable Number function is launched.
- [Aux Text](#)^[28]. You can now display axillary text for each cable that can be assigned to one of several variables.
- Many new [skins](#)^[60].

New Plugins:

- [Block extractor](#)^[103]. Extract all blocks from a drawing and write them to a folder.
- [Bulk Block Fixer](#)^[104]. Makes using manufacturer DWGs easier.

SDK Changes:

We have made the following non-breaking changes to the [Software Development Kit](#)^[150]:

Added Events

- `QueryNextSysNameNumber` - fired before WireCAD calculates the SysName. Allows custom formats.
- `QueryNextCableNumber` - fired before WireCAD calculates the next cable number. Allows customs formats.
- `ValidateCableNumber` - fired before WireCAD closes the Cable Edit dialog. Allows custom validation of cable data.

1.2 Software Activation

WireCAD v6 offers 3 program levels:

XL FREE, XLT and PRO. XLT and PRO require authorization keys in order to activate that level of the software. An activation key is all that is required to change program levels. If you have questions about the licensing scheme [click here](#)^[11].

Topics

[Floating Licenses](#)^[6]

[Floating License Leases](#)^[6]

[How To](#)^[7]

[Troubleshooting Activation](#)^[8]

Floating Licenses

Integral to WireCAD v6 is the ability to have a single authorization key activate multiple concurrent machines if your organization has paid for more than one seat. By default, when you purchase a seat of WireCAD your license count for your key will be set to 1 (one) operational.

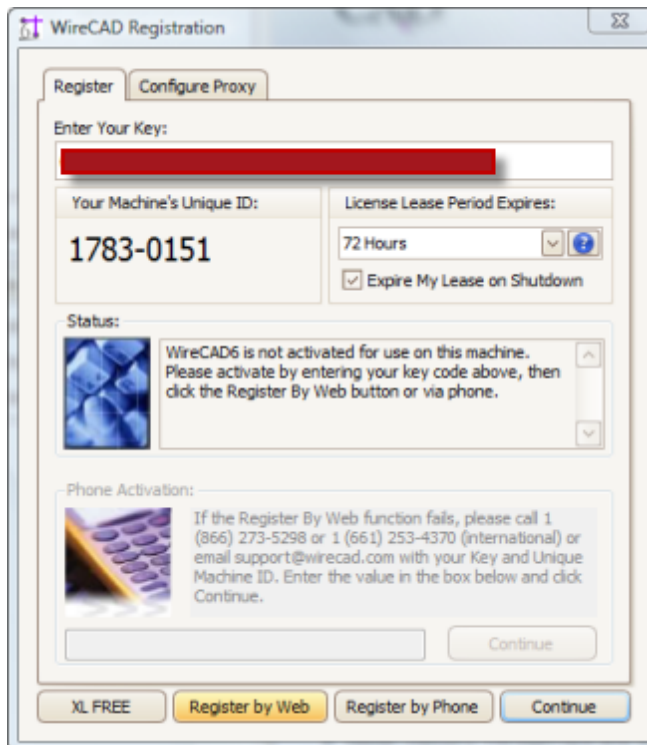

This will allow 1 (one) machine to be active at a time. You may install WireCAD on any number of machines throughout your organization; However, only one (or your license count) machine will be

Floating License Lease

The mechanism by which we float licenses is the license lease. Leases have expiration periods of 24, 48, 72, 168 hours and Never. During the activation of your software you will be prompted to pick a lease period. The lease period is period during which the software will run while being disconnected from the web. When you activate the software you are prompted for a lease length.

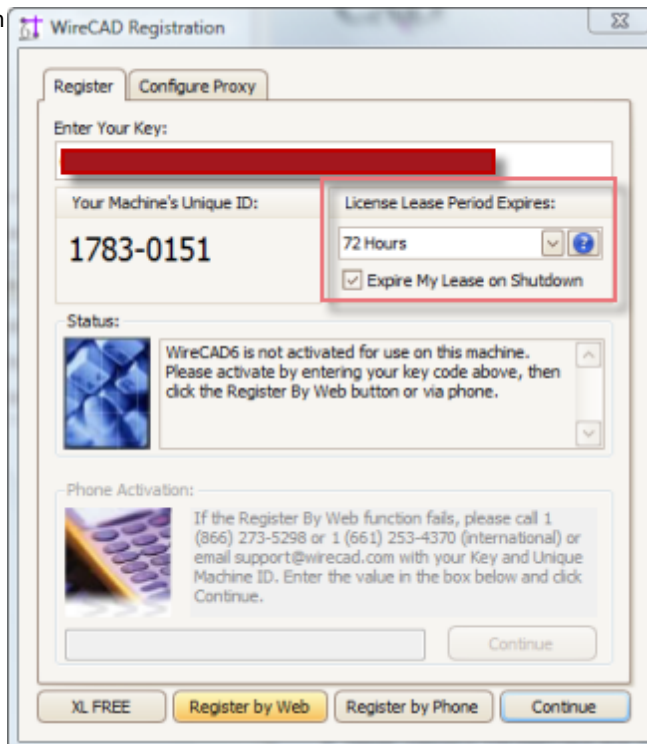

Once activated the application will run for the lease period. If you close the application while connected to the internet you will expire the lease; thus making it available to another machine. Upon application startup the license is validated and a lease is acquired automatically if web connected. If you cannot connect to the web you will need to phone WireCAD support at:
 1 661.253.4370 international.
 1 866.273.5298 US and Canada toll free.

How To: Activate WireCAD

- Enter your authorization key (it's the really long one that ends in 60. If you fail to enter the key correctly you will not be able to proceed.
- If you are web connected click the **[Register By Web]** button. If everything goes well you will see this message in the **Status** window.
- If you are not web connected you will need to call us at:
 1 661.253.4370 international.
 1 866.273.5298 US and Canada toll free.
- Click the **[Register by Phone]** button.

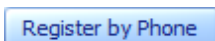
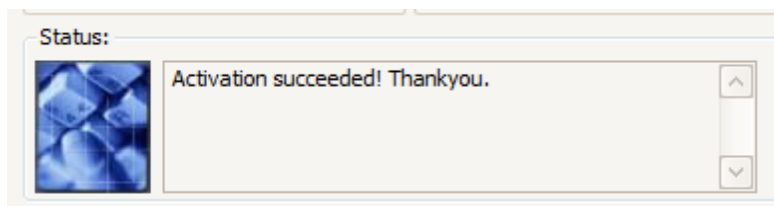
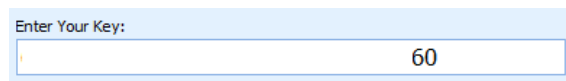

- You will be prompted by the WireCAD technician to set **Lease Period** to Never.
- The WireCAD technician will ask for your authorization key (it's the long one) **and** your **Machine ID**.
- The WireCAD technician will then read a series of numbers to you. Enter these in the Register by Phone text box.
- Next click the **[Continue]** button. You will receive a message box indicating the success of the activation.

License Lease Period Expires:

Never Expire My Lease on Shutdown

Your Machine's Unique ID:

1783-0151

Yours will be different

Phone Activation:

 If the Register By Web function fails, please call 1 (866) 273-5298 or 1 (661) 253-4370 (international) or email support@wirecad.com with your Key and Unique Machine ID. Enter the value in the box below and click Continue.

Troubleshooting Activation

The following are a few reasons your activation by web will fail:

1. Not connected
2. Lease already in use by another machine
3. Authorization key abuse
4. Authorization key not found in the database
5. Your machine Date/Time is more than twenty four hours out of sync with our web server (UTC).



If you wish to avoid the floating license scheme simply select Never as the lease length during activation. You will then lock the authorization key to that machine.

1.3 License Agreement

License Agreement

YOU SHOULD CAREFULLY READ THE FOLLOWING TERMS AND CONDITIONS BEFORE OPENING THIS PACKAGE AND/OR BY USING THE SOFTWARE. OPENING THIS PACKAGE OR USING THE SOFTWARE INDICATES YOUR ACCEPTANCE OF THESE TERMS AND CONDITIONS. IF YOU DO NOT AGREE WITH THEM, YOU SHOULD PROMPTLY RETURN THE PACKAGE TO THE LOCATION WHERE YOU PURCHASED THE SOFTWARE, UNOPENED WITH PROOF OF PURCHASE, AND YOUR MONEY WILL BE REFUNDED.

Holbrook Enterprises, Inc. provides this program and licenses its use.
Holbrook Enterprises, Inc. retains the ownership of this product.

LICENSE

Permitted Uses/You May:

- * Use the software on any computer provided the software is used on only one computer and by one user at a time.
- * Copy the program into any machine readable or printed form for backup or modification purposes in support of your use of the program on a single machine.

Prohibited Uses/You May not:

- * Make copies of the documentation or software, except as noted above.
- * Distribute, rent, sub-license, transfer, or lease the software or documentation.
- * Alter, modify or adapt the software or documentation, including, but not limited to, translating, decompiling, disassembling, or creating derivative works.

This license and your right to use the software automatically terminate if you fail to comply with the provisions of this License Agreement.

TERM

The license is effective until terminated. You may terminate it at any other time by destroying the program together with all copies, modifications and merged portions in any form. It will also terminate upon conditions set forth elsewhere in this Agreement or if you fail to comply with any term or condition of this Agreement. You agree upon such termination to destroy the program together with all copies, modifications and merged portions in any form.

IF YOU TRANSFER POSSESSION OF ANY COPY, MODIFICATION OR MERGED PORTION OF THE PROGRAM TO ANOTHER PARTY, YOUR LICENSE IS AUTOMATICALLY TERMINATED.

TRADE SECRET

You acknowledge that the software constitutes valuable trade secret information that is the exclusive property of Holbrook Enterprises, Inc..

Automatic Updates

Holbrook Enterprises, Inc. may periodically check the web for updates.
No personal information will be transferred.

LIMITED WARRANTY

Holbrook Enterprises, Inc. warrants for a period of 30 days from the date of original delivery to you that the program will substantially conform to the published specifications and to the documentation, provided that it is used on the computer hardware and with the operating system for which it was designed. Holbrook Enterprises, Inc. warrants the diskette(s) on which the program is furnished, to be free from defects in materials and workmanship under normal use for a period of ninety (90) days from the date of delivery to you as evidenced by a copy of your receipt. This warranty gives you specific legal rights. You may have other rights that vary from state to state.

DURING THE WARRANTY PERIOD, IF THE SOFTWARE DOES NOT PERFORM AS WARRANTED, YOUR EXCLUSIVE REMEDY SHALL BE TO SEND THE SOFTWARE TO HOLBROOK ENTERPRISES, INC.

WHICH SHALL, AT ITS OPTION, EITHER REFUND TO YOU THE PRICE PAID OR REPAIR OR REPLACE THE SOFTWARE.

To the extent permitted by applicable law, Holbrook Enterprises, Inc. disclaims all other warranties, either or implied, including, but not limited to, warranties of merchant ability and fitness for a particular purpose. Holbrook Enterprises, Inc. makes no warranty as to title. No Holbrook Enterprises, Inc. dealer, distributor, agent, or employee is authorized to make any modification or addition to this warranty.

LIMITATION OF LIABILITY

Because programs are inherently complex and may not be completely free of errors, you are advised to validate your work. TO THE EXTENT PERMITTED BY APPLICABLE LAW, IN NO EVENT WILL HOLBROOK ENTERPRISES, INC. OR ANY OF ITS PRINCIPALS OR AGENTS BE LIABLE FOR DIRECT, INDIRECT, SPECIAL, INCIDENTAL OR CONSEQUENTIAL DAMAGES WHATSOEVER ARISING OUT OF THE USE OF OR INABILITY TO USE THE PROGRAM OR DOCUMENTATION, even if advised of the possibility of such damages. Specifically, Holbrook Enterprises, Inc. is not responsible for any costs or damages including, but not limited to, those incurred as a result of lost profits or revenue, loss of use of the computer program, loss of data, the costs of recovering such programs or data, the cost of any substitute program, claims by third parties, or for other similar costs. IN NO CASE WHATSOEVER SHALL HOLBROOK ENTERPRISES, INC.'S LIABILITY EXCEED THE PRICE PAID FOR THE LICENSE TO USE THE SOFTWARE.

SOME STATES DO NOT ALLOW THE LIMITATION OR EXCLUSION OF LIABILITY FOR INCIDENTAL OR CONSEQUENTIAL DAMAGES SO THE ABOVE LIMITATION OR EXCLUSION MAY NOT APPLY TO YOU.

Should you have any questions concerning this Agreement, you may contact Holbrook Enterprises, Inc. by writing to:
Holbrook Enterprises, Inc.
4286 E. Amity Ave Suite 101
Nampa, ID 83687
(661) 253-4370

You acknowledge that you have read this agreement, understand it and agree to be bound by its terms and conditions. You further agree that it is the complete and exclusive statement of the agreement between us which supersedes any proposal or prior agreement, oral or written, and any other communications between us relating to the subject matter of this agreement.

1.4 Licensing FAQ

The following are some frequently asked questions about the WireCAD licensing scheme.

Q: Does WireCAD support floating licenses

A: Yes, if you choose to use the function it is built in to both XLT and PRO. You may disable this feature by selecting the Never expire option on the License Lease Period dropdown at activation time. Choosing to do so limits that Authorization Key to that machine only.

Q: How many machines can I install WireCAD on?

A: You may install WireCAD on any number of machines. You will only be able to launch WireCAD on as many machines as your license count supports. The default license count is 1. If you wish to purchase additional licenses you may want to consult with your WireCAD sales professional who will help you decide the best course of action.

Q: I have a laptop and a desktop WireCAD used to let me install on both. How come I have to choose?

A: You don't. WireCAD will still install on both. It will only run on one at a time.

Q: What happens if my machine dies?

A: If your machine dies and you are using the floating license scheme, one of two things will happen:

- 1. Install WireCAD on the new machine and wait for your lease to expire in what ever lease expiration period you selected (not optimum, but serviceable).**
- 2. Call the WireCAD sales team. They can manually expire the lease for you. You will need your authorization key and company name, as well as the machine name of the machine that died.**

Q: I am not connected to the internet very often, can I still use the floating license scheme?

A: We recommend that you use the floating license scheme only if you are regularly connected to the web

Q: I am going on-site. How do I ensure that my copy of WireCAD will stay active while I am disconnected from the web?

A: If you are using the floating license scheme and you know that you will need to be occasionally connected for a short period of time (one week or less). Click Project>Settings[Application Settings] set the Release License on Shutdown to false. This will ensure that only your machine has the license for up to the lease period. If you are not sure how long you will be gone, follow this procedure:

- 1. Click Help>Control Software Activation.**
- 2. Click [De-activate this Copy of WireCAD]. You need to be web connected. Make sure that the server responds that the license has been successfully released.**
- 3. Set the License Lease Period dropdown to Never.**
- 4. Click [Register by Web].**

WireCAD will not require a web connection to start.

Q: What are the benefits of the Assurance Subscription?

A: A current Assurance subscription gives you the following premium benefits :

- **Free major and minor version upgrades and hotfixes.**
- **Priority technical support.**
- **New samples, tips and how-to topics from time-to-time.**
- **Discounts on training.**
- **Access to beta products.**
- **Assurance Price Lock guarantees that your annual Assurance rate will not increase year-to-year as long as you remain current.**

Q: Does the license expire if the Assurance Subscription expires?

A: No. Your licence does not expire even if your Assurance expires. You can use the products indefinitely even after the Assurance subscription expires.

Q: How long does my Assurance Subscription remain valid?

A:Your subscription duration is for 1 year from date of purchase or renewal.

Q: My Assurance Subscription is about to expire. What should I do?

A:You must renew your subscription to continue to receive the latest versions for free along with all the other benefits of the subscription. To renew your Assurance, contact sales@wirecad.com.

Note that you may or may not receive notifications from Holbrook Enterprises, Inc. dba WireCAD about the pending expiration of your subscription. It is your responsibility to renew your subscription when it is about to expire. You can renew your subscription as early as you want or opt for a monthly credit card payment.

Q: When can I renew my subscription?

A:You must renew your subscription before the expiration of your current subscription You can renew your subscription anytime before your current subscription has expired; you will not lose any days as the new subscription will come into effect on the day your current subscription ends. In effect, your current subscription will be extended by 1 year.

If you do not renew your subscription before the expiry of your current subscription, your subscription is considered as lapsed and you will not be eligible for free upgrades and other benefits anymore.

Q: My Assurance subscription has lapsed. How can I get the latest version?

A:Maintaining your Assurance subscription and renewing your subscription each year to keep it current is the best and the most cost-effective way to receive all new major and minor versions as they are released. In case your subscription has lapsed and you want to upgrade to the latest version you may simply renew your Assurance subscription at the current rates.

Q: Do you offer academic discounts?

A: We do have academic discounts if WireCAD will be used for education/ research purposes. Please contact sales@wirecad.com for more information.

Part

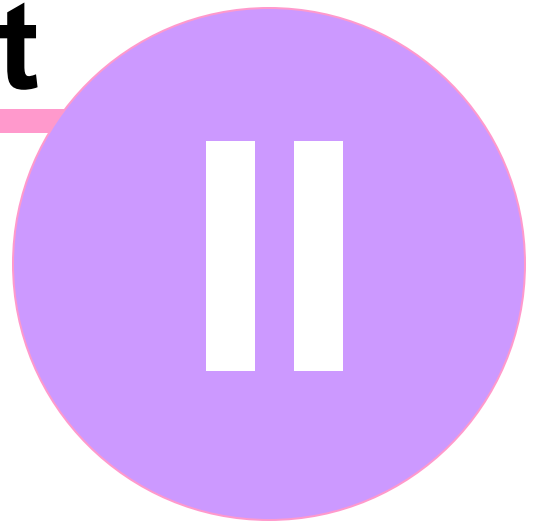

2 Getting Started

Contents

Workflow Diagram	14
Setting Up Your Global Data	16
Equipment Library	17
Creating a New Project	22
Creating a New Drawing	23
Creating a New Equipment Definition	19
Adding Equipment to Drawings	20
Drawing Cables	24
Assigning Unique IDs (SysNames)	36
Assigning Cable Numbers	38
Assigning Terminals	39
Rack Builder Tool	41

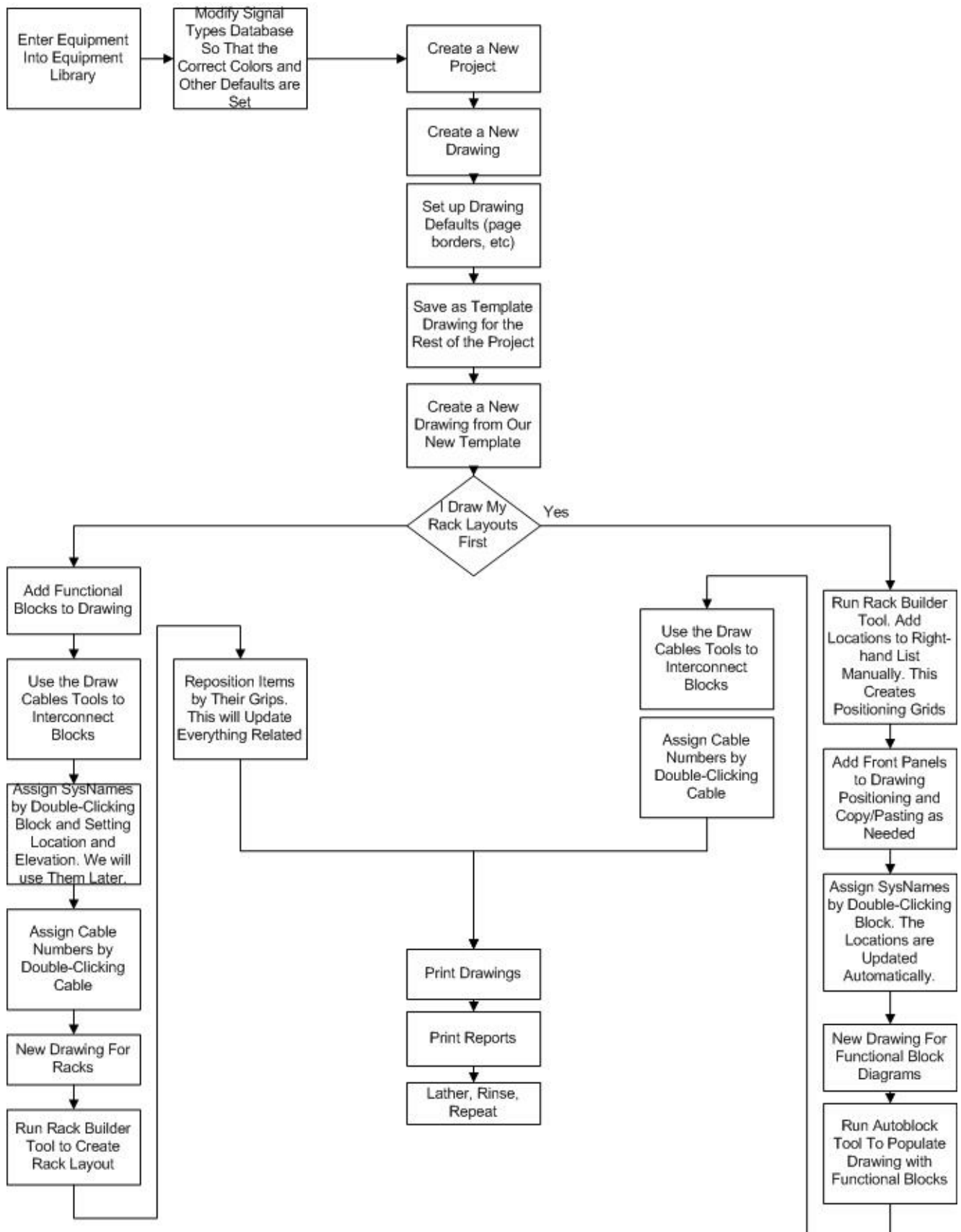

2.1 Setting Up Your Global Data

Menu: **Several**

Default command line shortcut: **several**

Applies To:
All product levels
Related Settings:
None

WireCAD maintains a global database with tables representing Manufacturers, Equipment, Signal Types, Connectors, Etc.

Getting started with WireCAD entails setting up the global databases to fit your needs. While the database is populated with data you may find that it suits your needs to purge the data and start fresh. If this is the case we can provide empty databases. At the very least you will want to set up the Signal Types grid with your defaults.

Next you will customize the Equipment Library with the products and IO that you use. In order to do this, you may either download existing products from the WireCAD Community Server or [enter your own](#)^[19].

- Manufacturers** - The topmost table in the heirarchy
- Equipment** - The Equipment description
 - Inputs** - inputs of a device
 - Outputs** - outputs of a device
- Signal Types** - signal types and a bunch of defaults.
- Connectors** - connector types.
- Pinouts** - pin out definitions (data).
- Color Codes** - color code lookup. Used by Cable Types.
- Cable Types** - cable type information.
 - Cable Cores** - cores or conductor data for a cable type.

Accessing the Global Data

The Project Explorer

The Project Explorer allows access to the global data grids.

You can also access these grids from the **Database** menu.

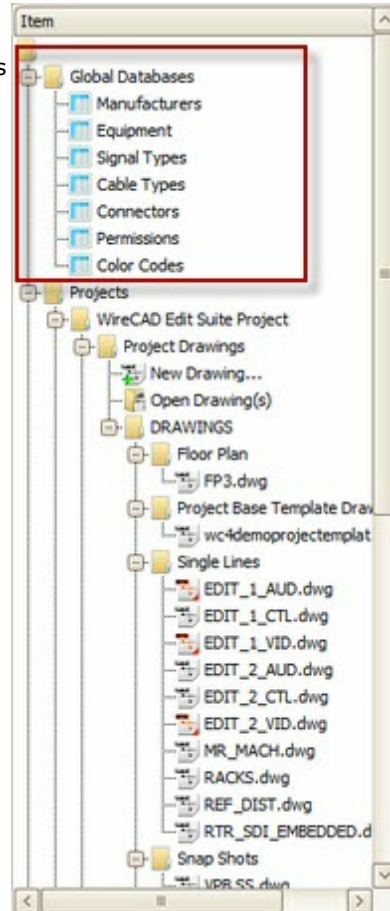

Database>Equipment Library Opens the Equipment Library where you will do most of your work.

2.2 Equipment Library

Menu: **Database>Equipment Library**

Menu: **Advanced Tools>Equipment Library**

Default command line shortcut: **LE**

The WireCAD Equipment Library is where you will spend a fair amount of time as you get define equipment that you will use in your designs. This is also where we come to create CAD blocks in our drawings. There are many settings here that let you customize appearance. This chapter is the basics.

Applies To:
All product levels
Related Settings:
None

Equipment Library

Find Tab

Find equipment definitions in the global database or the Community Server.

Preview the block before adding ²⁰ to drawing.

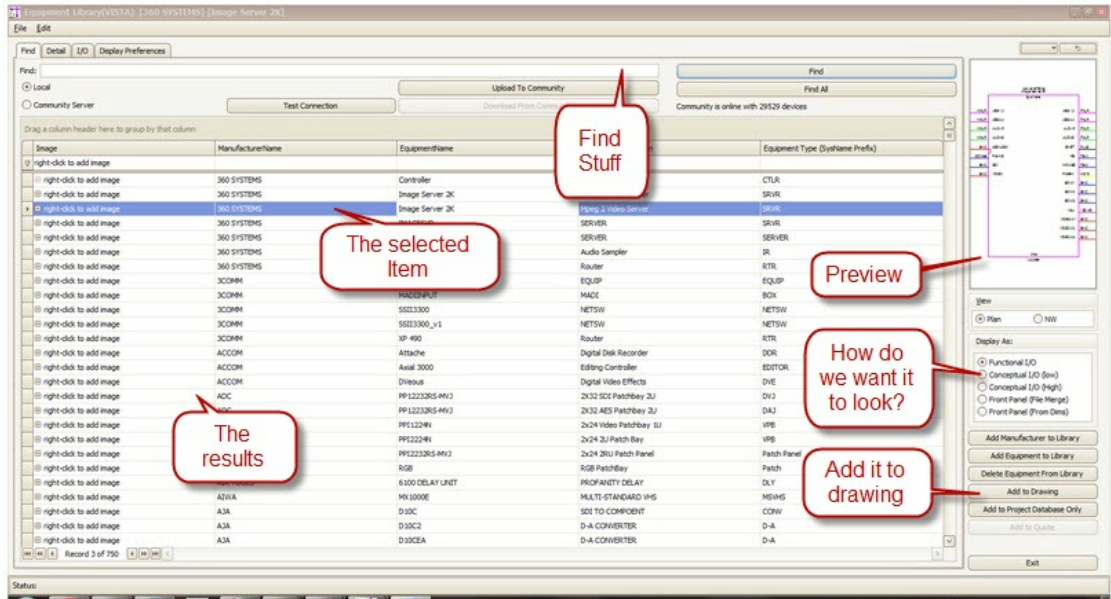

Detail Tab

Edit details. Associate with external files.

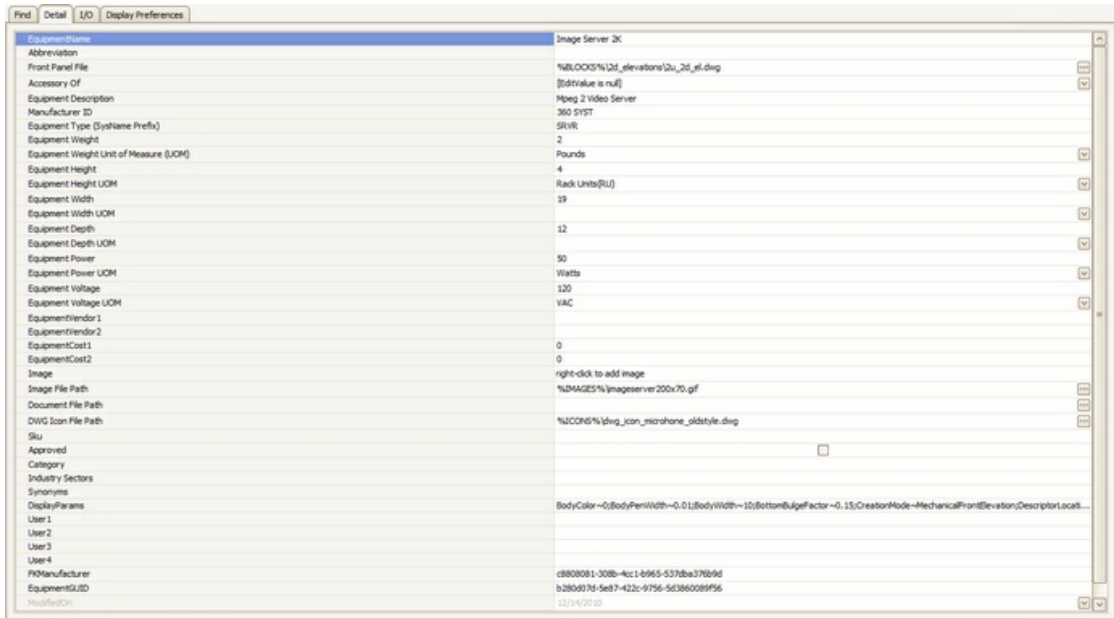

IO Tab

Add , edit, select IO to display in created block.

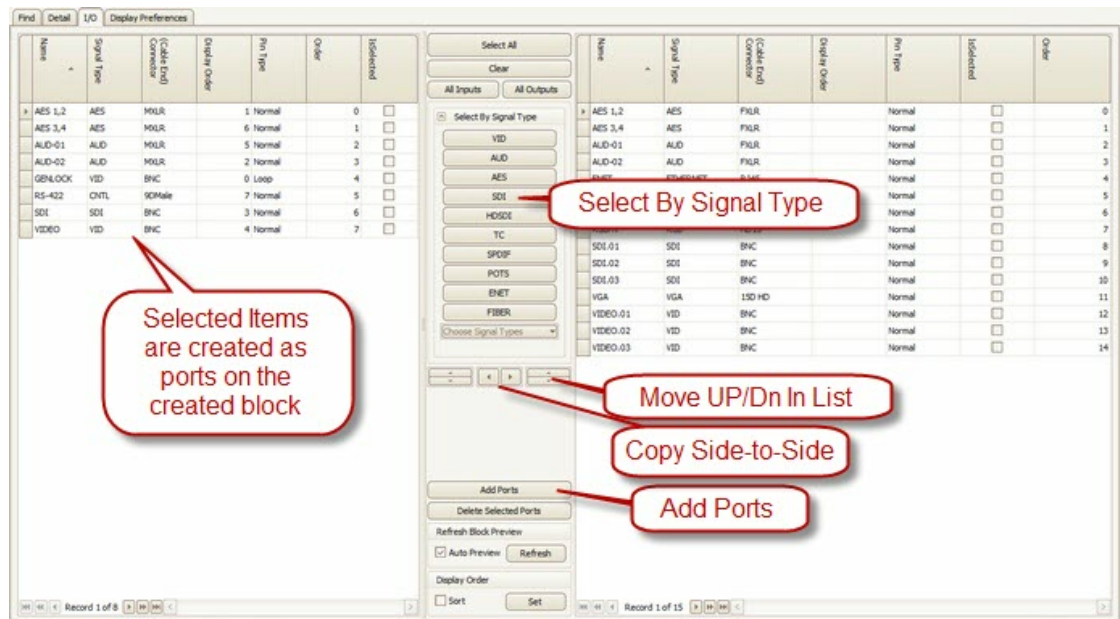

Display Preferences

Controls the appearance of the created block.

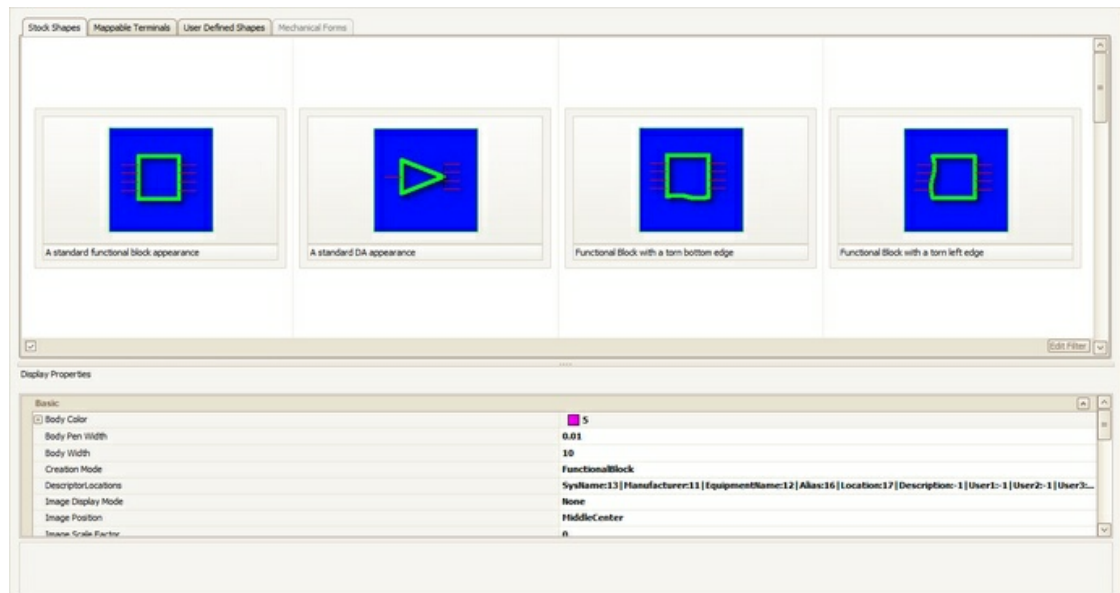

2.2.1 Creating a New Equipment Definition

Menu: **Database>Equipment Library[Add Equipment to Library]**

Default command line shortcut: **le**

Create a new equipment definition from which to create functional blocks, rack panels, etc.

Applies To:
All product levels
Related Settings:
None

How To: Add Equipment to the Library

1. Click **Database>Equipment Library**
2. Click **[Add Equipment to Library]**
3. Select or add a manufacturer.
4. Enter model/pn/name, description, etc
5. Click **[Next >]**
6. This page is optional, but we recommend filling in the **Front Panel File** field
7. Click **[Next >]** to add the new definition

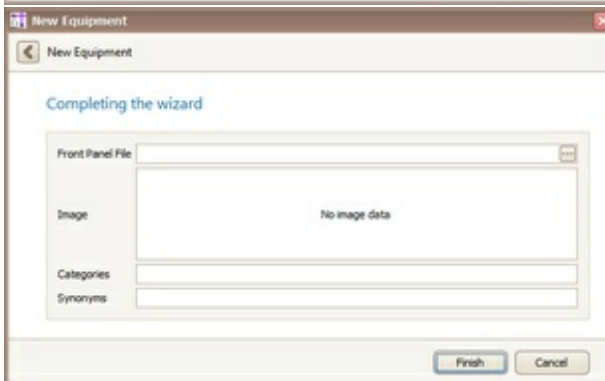
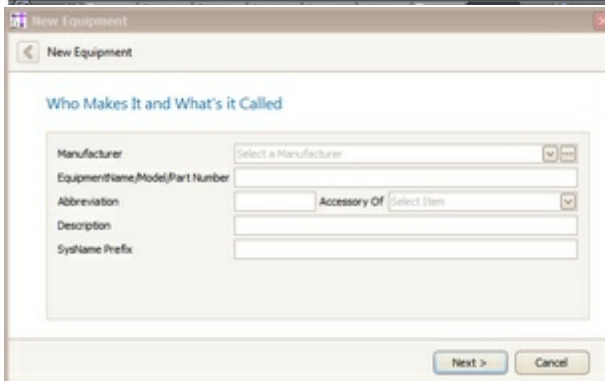
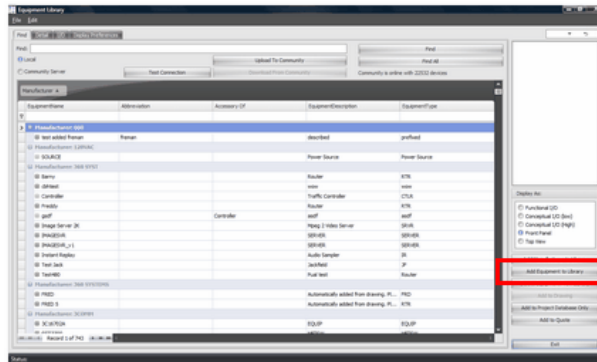

1. Select the newly added device from the list. If not found click **[Find All]**
2. Add the IO by selecting the IO tab
3. Click **[Add Ports]**
4. Enter a port name, connector, signal type
5. Select **Inputs, Outputs** table or **Both**
6. Click **[OK]** or **[Apply]** (if you want to leave the form open).



2.2.2 Adding Equipment to Drawings

Menu: **Database>Equipment Library [Add to Drawing]**
 Default command line shortcut: **le**
 Create a new equipment block from the library and add it to the current drawing.

Applies To:
 All product levels
 Related Settings:
 None

How To: Add Equipment to Drawings

Find the select the equipment definition from the Equipment Library.

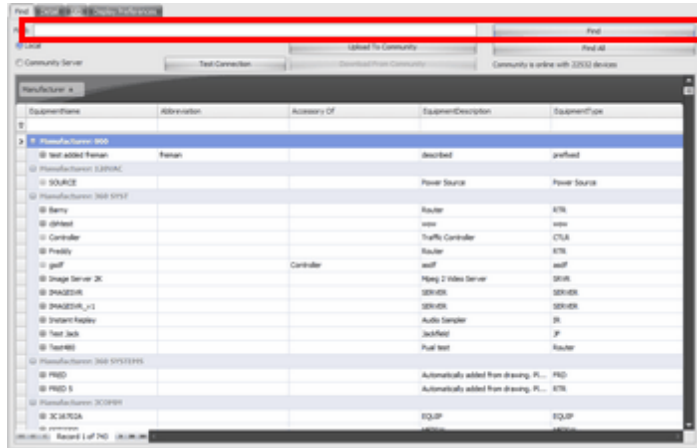

Select the IO you want to display in the drawing

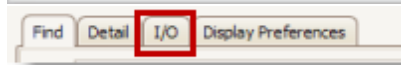

Select the Display mode

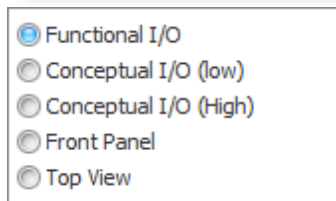

Select the Display Preferences. Everything is parametric. There are settings for Body Width, Pin Spacing, Color, etc.

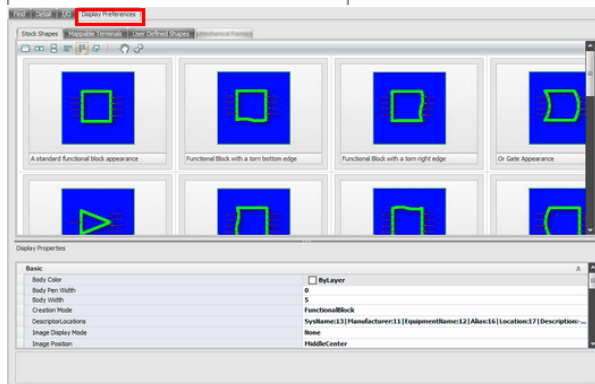

If the **Auto Preview** function is not set, you may wish to click the Refresh button (either above the preview window or on the **IO** tab).

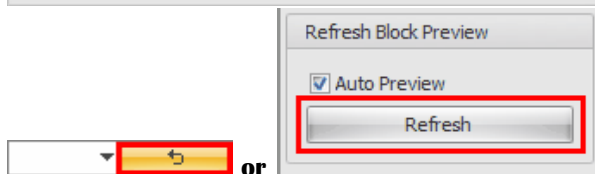

Click **[Add to Drawing]** (requires an active drawing).

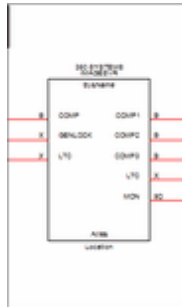

Place the newly created block in the drawing.

2.3 Creating a New Project

Menu: **Project>New Project**

Default command line shortcut: **np**

Create a new WireCAD Project structure. This involves folder structures on your operating system as well as databases and support files.

Applies To:
All product levels
Related Settings:
None

WireCAD v6 can create projects with a number of different database formats. You may choose to create a new project using file based databases for their zero admin capabilities, or SQL Server for an enterprise installation.

How To: Create a New Project

1. Click **Project>New Project**
2. Click **[Next >]**
3. Select the type of database you wish to use
4. Click **[Next >]**
5. Enter project info
6. Click **[Next >]**
7. Enter host info (SQL Server only)
8. Click **[Next >]** to finish

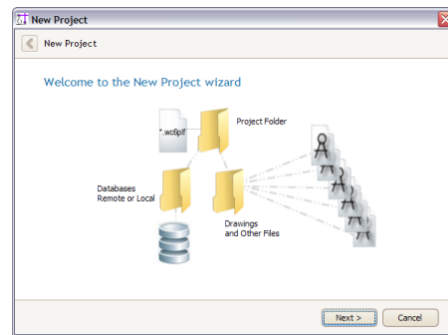

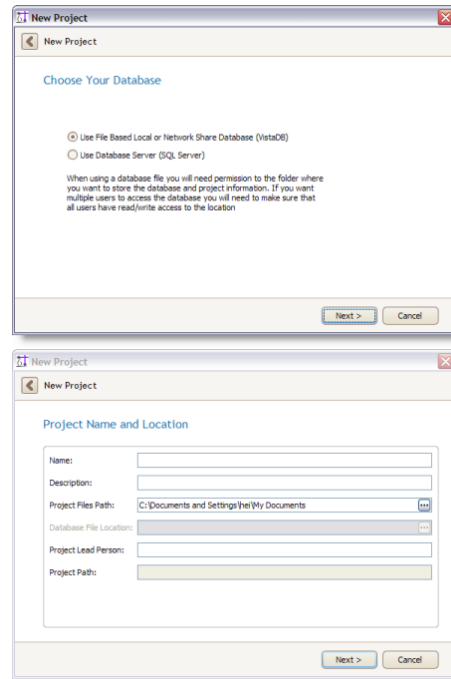

2.4 Creating a New Drawing

Menu: **File>New Drawing, Project Explorer\Current Project\New Drawing**

Default command line shortcut: **nd**

Create a new drawing based on a drawing template, with or without model space boundaries.

Applies To:
All product levels
Related Settings:
None

How To: Create a new drawing using the wizard

1. Click **File>New Drawing**
2. Select a template drawing from which to start
3. Click **[Next >]**
4. Select boundary settings
5. Click **[Next >]** to finish

Template drawings are drawings that have been saved in the template drawings folder and already have entities such as page borders, layouts and viewports added to them.

Create Model Space Boundaries. The Model Space Boundaries function takes two arguments, the **Model Space Text Height** and the desired **Printed Output Text Height**. Using these two variables in conjunction with the size of the Viewports in each Layout to create boundary rectangles in the Model space. Each boundary is accompanied by a text description that describes the Viewport and to which the boundary applies as well as the **text heights** and **scale factor**.

Note: You can add **Model Space Boundaries** later using the **Format>Boundaries** function

The final step is to name the drawing.

2.5 Drawing Cables

WireCAD provides a series of tools to draw cables. The only rule that this version of WireCAD imposes is that you must draw from one WireCAD device to another. You cannot draw a cable representing a spare that connects to nothing.

WireCAD provides a cable auto-routing tool that automatically routes the cable around other devices and, if selected, avoids other cables. The auto-router will always find a path for the cable, even if it means that the cable is drawn through another device or must overlay another cable. If you do not like the way a cable is routed, you have two choices; first: manually drawing the cable by selecting Manual Draw, second: select the cable and grab a grip on the cable and move it around.



If you manually draw cables or otherwise put them where you want them and then move a device, the auto-router will be invoked and re-route all your changes.

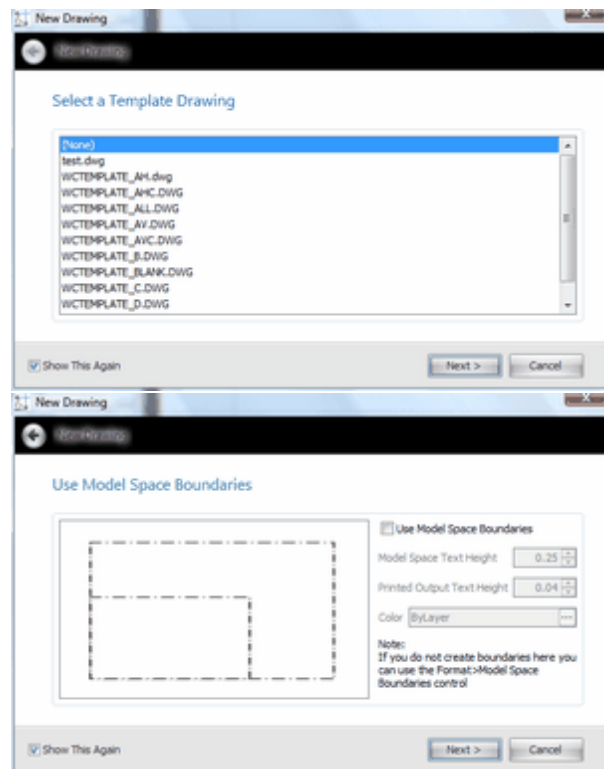

Topics

[WireCAD Cable Terminology](#) [25]
[Draw Cables Toolbar](#) [25]
[One-to-One Cable](#) [26]
[Aux Text](#) [28]
[Manual Draw Cables](#) [27]
[Cable Router X Offset](#) [29]
[Cable Router Y Offset](#) [30]
[Default Pointer](#) [30]
[One-to-Many Cable](#) [30]
[Many-to-One Cable](#) [32]
[Many-to-Many Cable](#) [33]
[Terminal as Source](#) [34]
[Terminal as Destination](#) [35]

WireCAD Cable Terminology

Devices have inputs and outputs, Cables have sources and destinations. For purposes of this manual we will refer to Jacks, Junction Boxes, Router Crosspoints, Bulkhead connectors, and On-Sheet/Off-Sheet Pointers collectively as **Terminal s**:

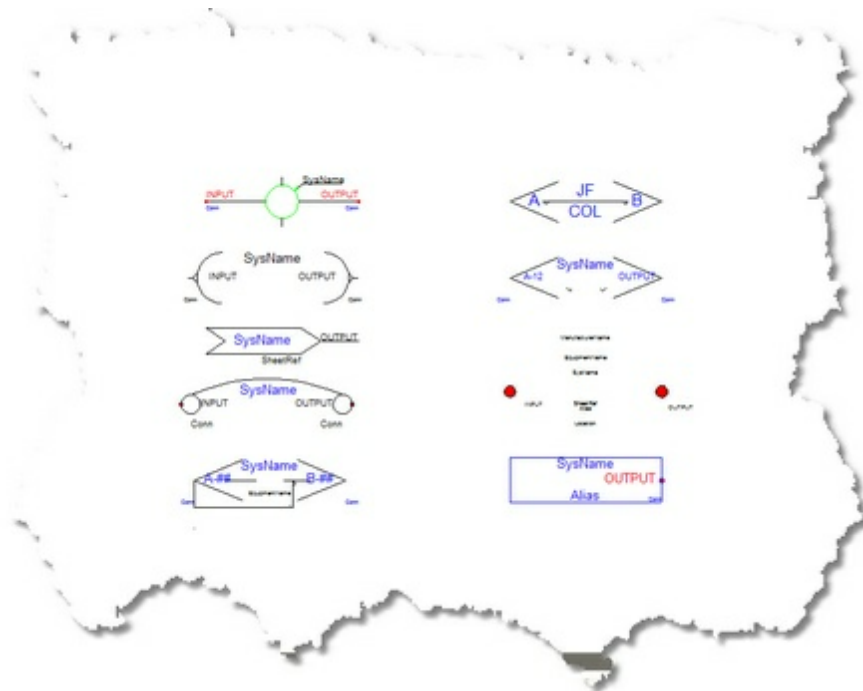

Draw Cables Control Descriptions

Item	Description
------	-------------

Draw Cable Toolbar	
--------------------	--

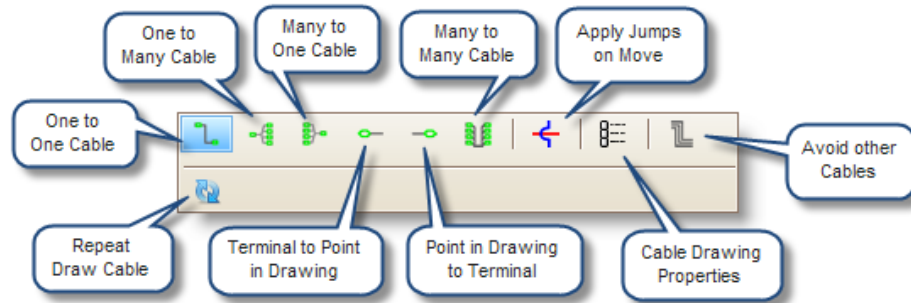

One-to-One Cable



Cable Text Height The Cable# text entity height in DU.

Replace Cable with Pointers checkbox

Automatically draw Pointers instead of cables.

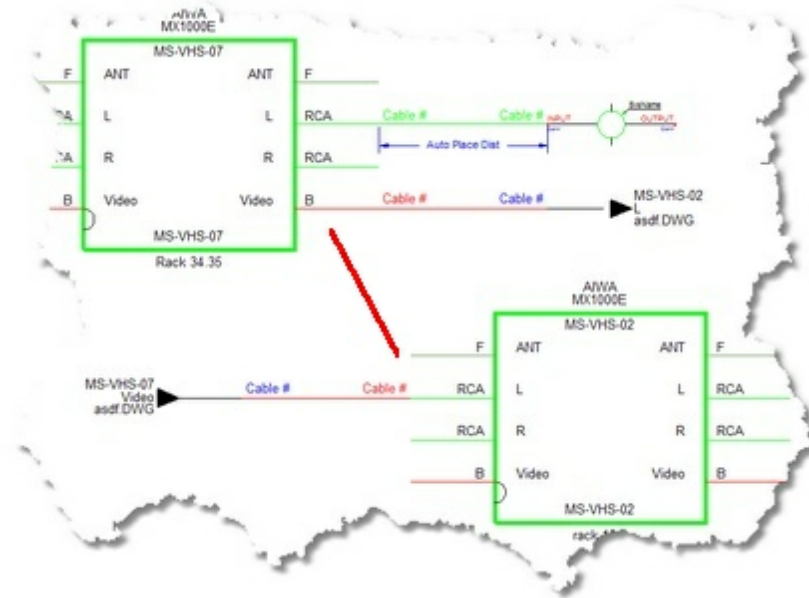

Manual Draw checkbox

Draw every point in the cable.

Avoid Other Cables checkbox

Allows cables to overlay each other. True =

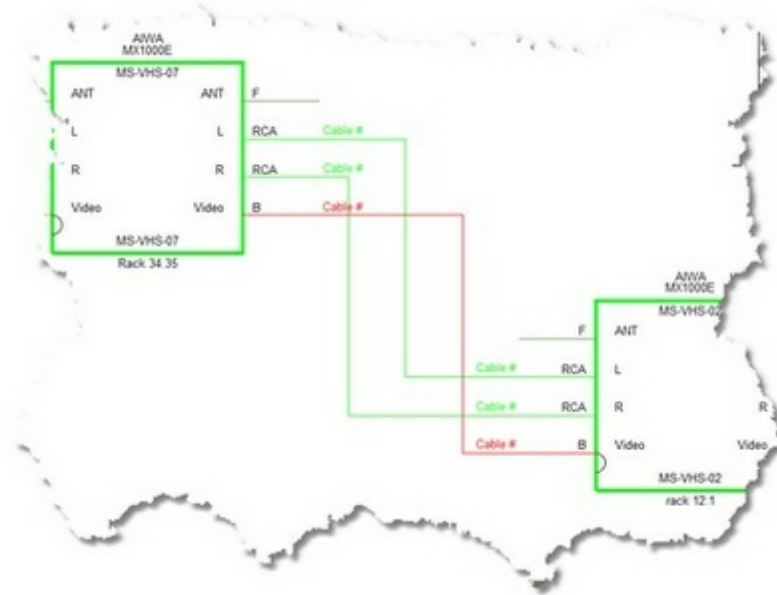

False =

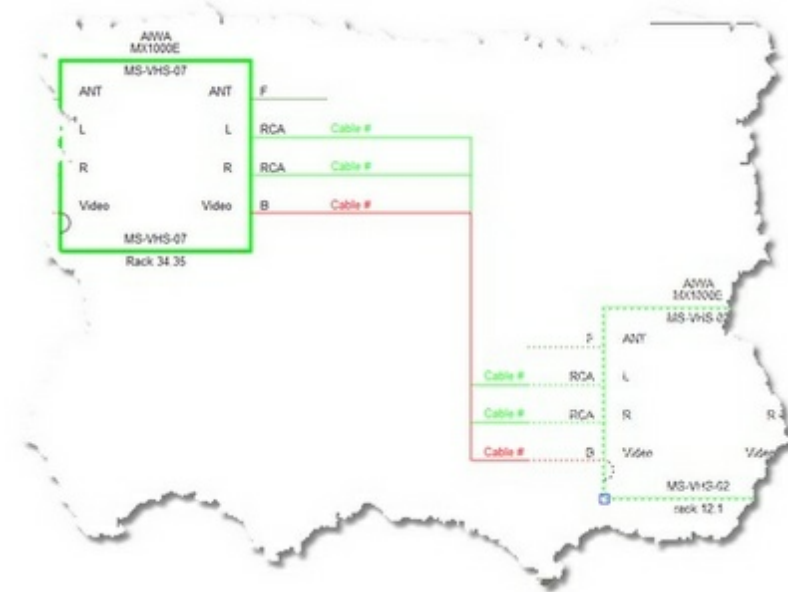

Aux Text Enable

Enable the placement of Aux Text.

Aux Text Height

The height in DU of the Aux Text.

Location

The position of the Aux Text relative to the cable polyline.

Over - positioned over the cable polyline.

Under - positioned under the cable polyline.

Bubble - Not yet supported.

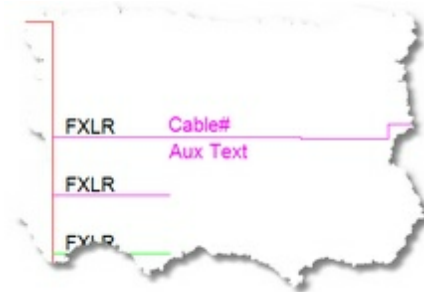

Variable

You may choose to populate the Aux Text with the following variables:

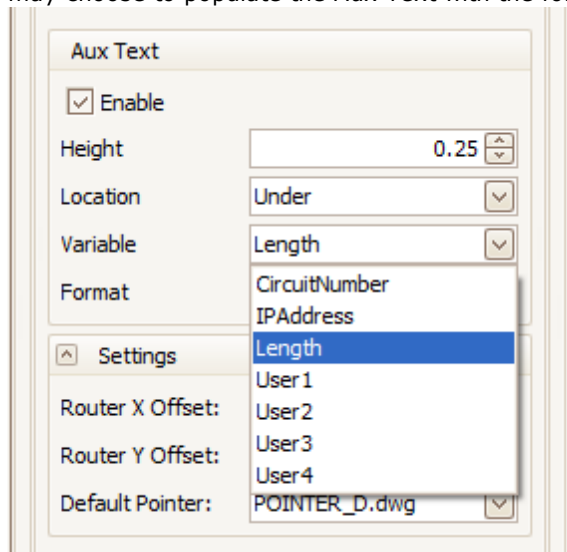

CircuitNumber - The Circuit Number as entered in the Cable Edit Dialog.

IPAddress - Not yet implemented.

Length - The Length field as entered in the Cable Edit Dialog.

User1 - The User1 as entered in the Cable Edit Dialog.

User2 - The User2 as entered in the Cable Edit Dialog.

User3 - The User3 as entered in the Cable Edit Dialog.

User4 - The User4 as entered in the Cable Edit Dialog.

Format

{0} represents the data from the selected variable.

Example: the incoming data from the selected variable is 300 and you want to format it to represent meters to the reader. Your format field would be {0}m. The output would be formatted as 300m.

X Offset

Horizontal auto-router offset. When drawing cables, WireCAD uses an auto-routine algorithm. The X Offset determines how far away horizontally from other equipment and cables a new cable will rout.

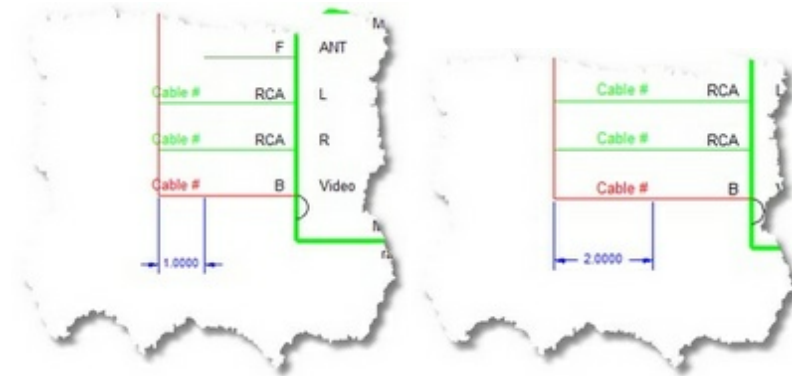

Y Offset

Vertical auto-router offset. When drawing cables, WireCAD uses an auto-routine algorithm. The Y Offset determines how far away Vertically from other equipment and cables a new cable will rout.

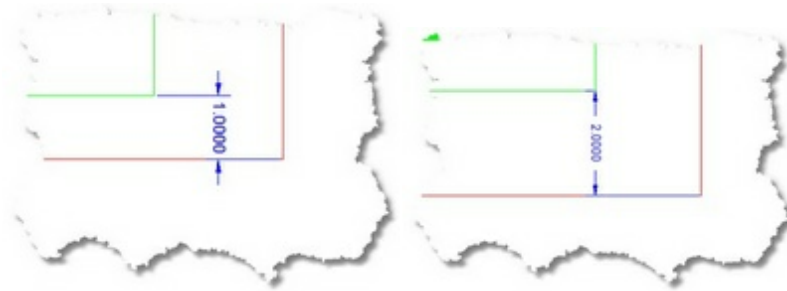

Default Pointer Select the pointer to use when replacing cable with pointers

One-to-Many Cable

Explanation Used to indicate one output to many inputs

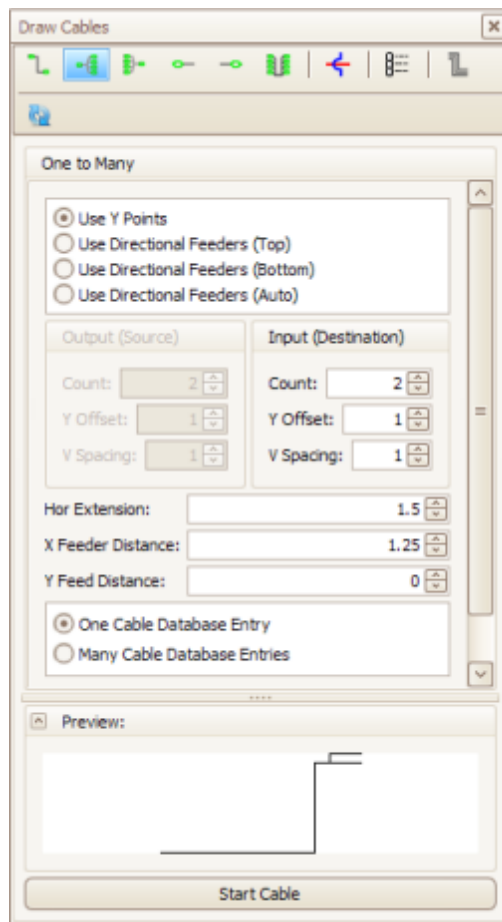

Feeder selection

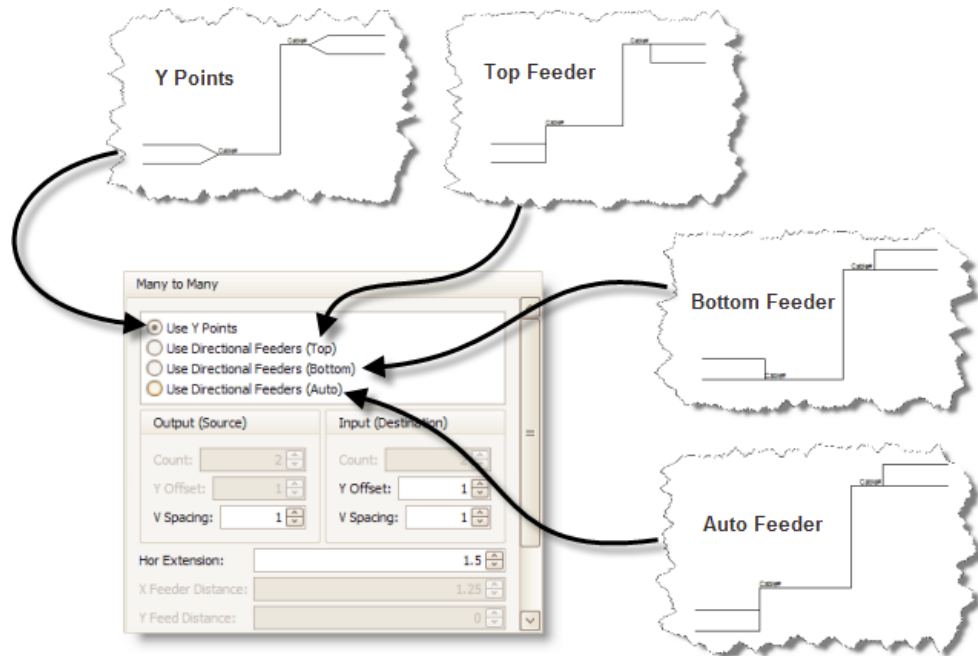

Count

Destination count

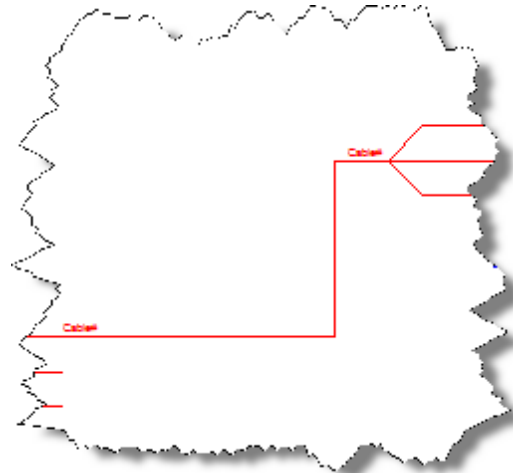

Count=3

Y offset, Y Spacing, Hor Extension

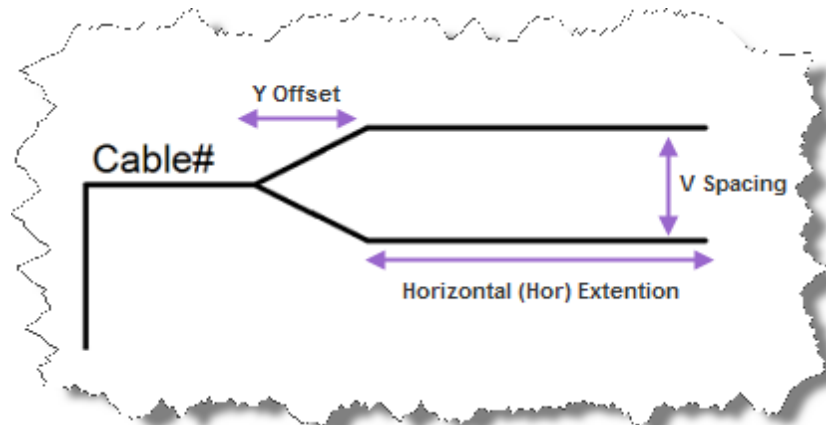

Feeder distances

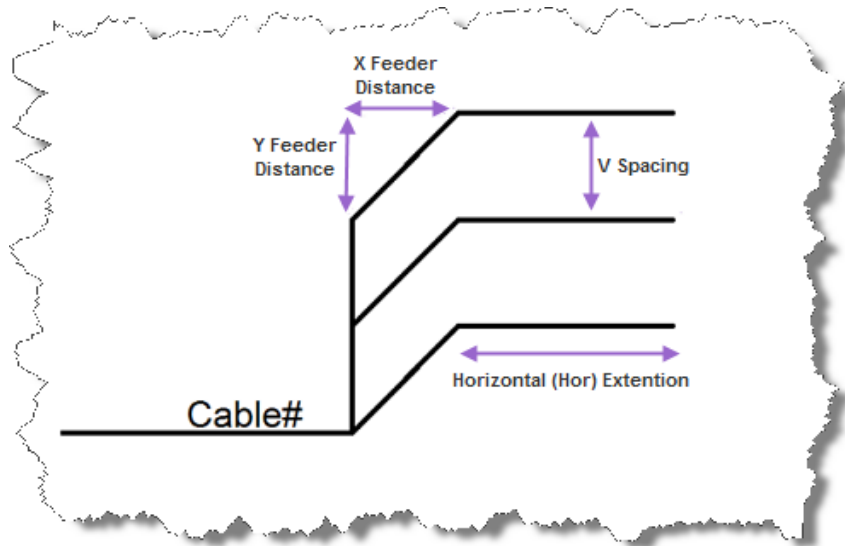

One Cable Database Entry

Adds a single entry in the cables database and one Cable# text entity at the Y point.

Many Cable Database Entries

Adds a many entries in the cables database and many Cable# text entity at the connection points.

Note: One-to-Many and Many-to-One cables set to Many Cable Database Entries will assign the connection point closest to the cursor when the cable is double-clicked. The first assignment on the cable will enter the database as expected, subsequent assignments will display the Existing Ports dialog prompting you to decide how to number the cables.

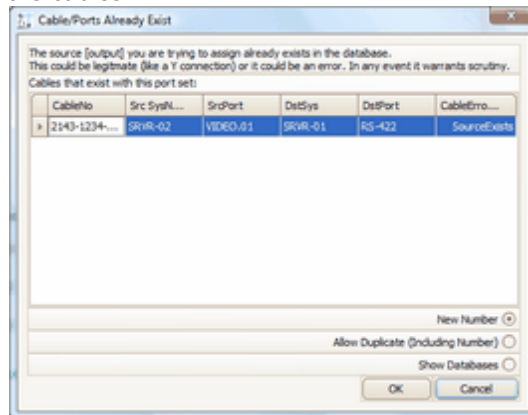

Many-to-One Cable

Explanation

Multiple outputs to one input

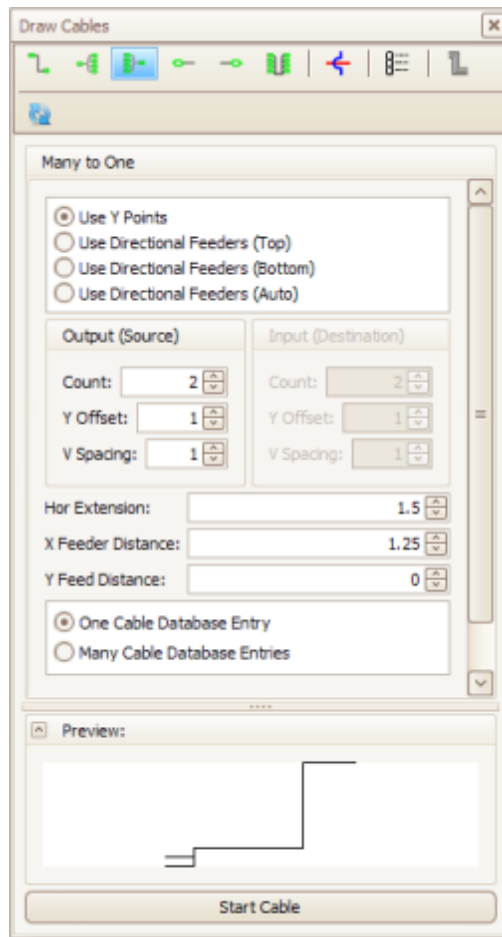
**Count**

Source count

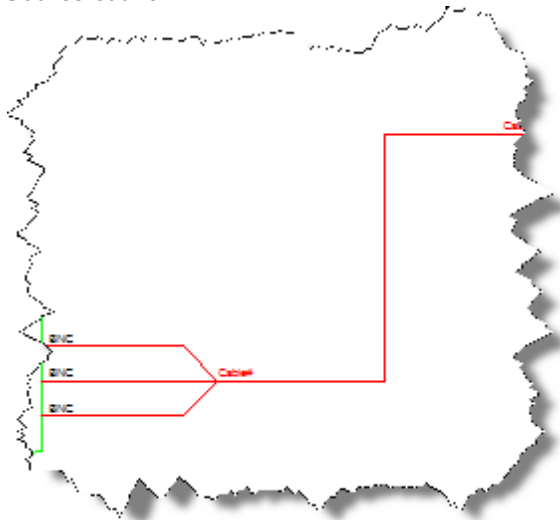
**count=3****More information** See above for a description of other settings**Many-to-Many Cable**

Explanation

Many-to-Many cables behave like a buss. They are a collection of one-to-one cable drawn as a single polyline. When assigning cable numbers the connection point closest to the cursor is used.

See the above descriptions for more information about settings.

Count

Source and destination count

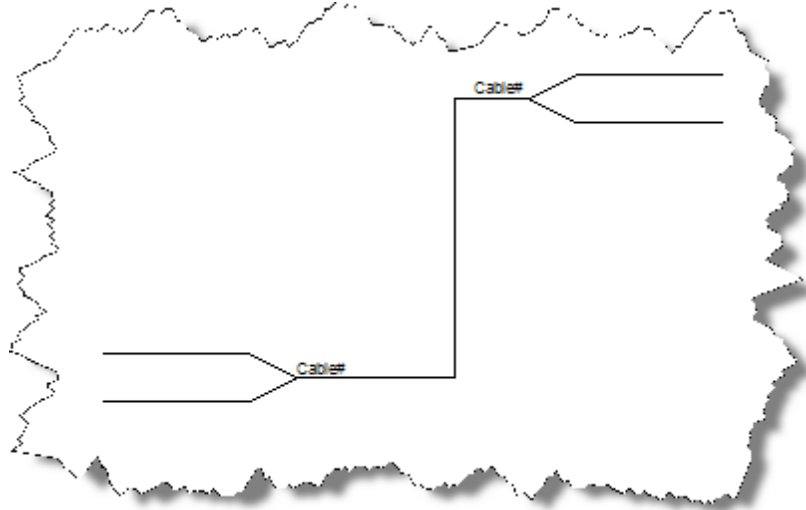

Count = 2
Y feeder

Terminal as Source Window

Displays the available Terminals sorted by Terminal style (Jack, Terminal, Pointer).

Note: Terminal file suffixes determine whether the file will be displayed in this window. Files having a `_SD`, `DWG`, or `_S.DWG` suffix will appear in this view.

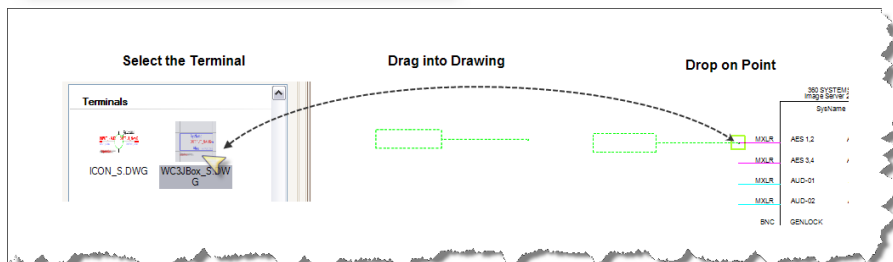
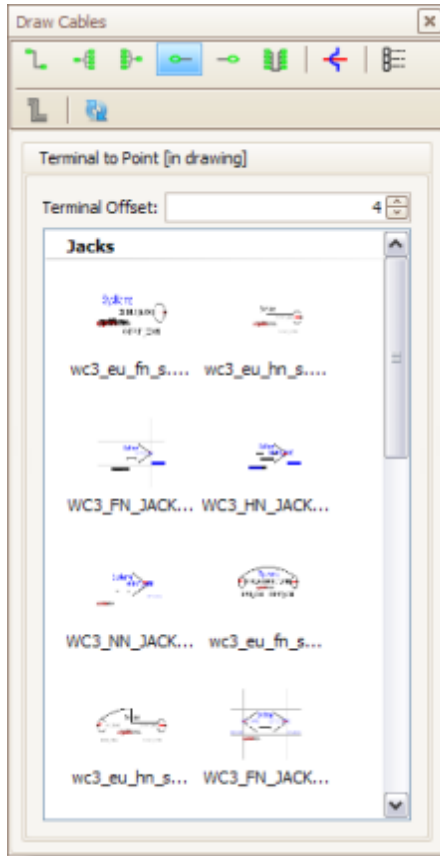

Terminal Offset

Sets the distance between the connection point and the terminal basepoint

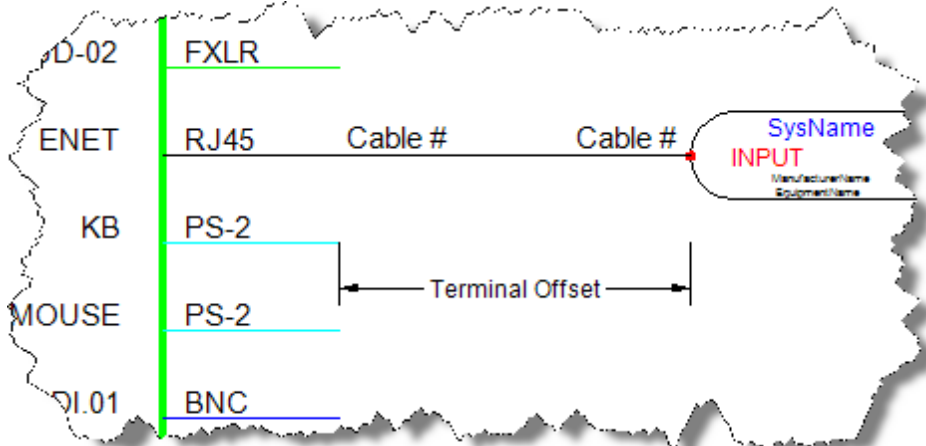

Terminal as Destination Window

Displays the available Terminals sorted by Terminal style (Jack, Terminal, Pointer).

Note: Terminal file suffixes determine whether the file will be displayed in this window. Files having a `_SD.DWG`, or `_D.DWG` suffix will appear in this view.

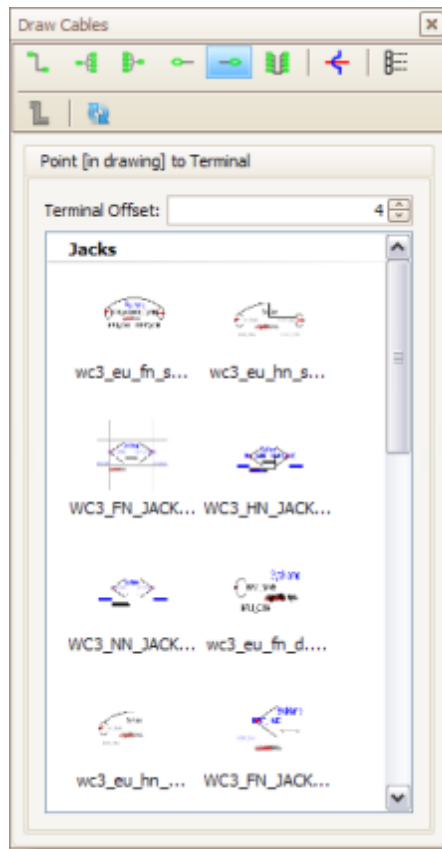

Terminal Offset see above

2.6 Assigning Unique IDs (SysNames)

Menu: **Advanced Tools>Equipment Functions>Assign SysName**

Default command line shortcut: **as**

Alternately: double-click the equipment block in the drawing.
Assign a unique ID to blocks in a drawing.

Applies To:
All Product Levels
Related Settings:
[SysName Format](#)^[79]

This function performs the following steps:

1. Gets the next number in the sequence (based on the [SysName Format](#)^[79]).
2. Prompts the user for input.
3. Updates the drawing
4. Updates the project systems database.

Note: if the project contains related projects, you will be notified of duplicate SysNames in related projects

Edit SysNames Dialog

SysName

If you manually enter a SysName it must follow the format defined in the SysName Format tool. The SysName textbox will be masked to help you follow the format.

Fill Gaps ...

Gaps in sequences can be filled automatically and then selected from the SysName dropdown.

Alias

Alias is functional name for the device. Think of it like the friendly name. The SysName is the unique ID the Alias can be duplicated if desired.

Example: If the device is a distribution amp and its SysName is DA-120 and it is fed by SVR-01, you may choose to alias it as its source SVR-01.



We recommend that you enter a Location and Elevation. Take your best guess. The Rack Builder tool will use your guesses to create a preliminary rack layout that can easily be modified to suit your final design

Various flags to help you sort the equipment in your Systems table.

Not Yet Implemented

Various fields to track, IP address, Power Consumption, etc

User fields

Flags
IsSequential
Engineering Data
tab
User Data tab

2.7 Assigning Cable Numbers

Menu: **Advanced Tools>Cable Functions>Assign Cable Number**

Default command line shortcut: **ac**

Alternately: Double-click the cable in the drawing

Assumes that the devices on both sides of the cable have first been assigned SysNames.

To assign multiple cables at once, create a selection of cables. The order the cables are added to the select set is the order that they will be assigned numbers. Once you have created a selection of cables, click: **Advanced Tools>Cable Functions>Assign Cable Number**, or type **ac** into the command line followed by the **[Enter]** key.

This function performs the following steps:

1. Gets the next number in the sequence (based on the [Cable Number Format](#)^[81])
2. Prompts the user for input
3. Updates the drawing
4. Updates the project systems database

Applies To:

All product levels

Related Settings:

[Cable Number Format](#)^[81]

[Project Settings](#)^[58]

Note: if the project contains related projects, you will be notified of duplicate Cable numbers in related projects

Edit Cable Numbers Dialog

CableNo

If you manually enter a Cable Number it must follow the format defined in the Cable Number Format tool. The CableNo textbox will be masked to help you follow the format

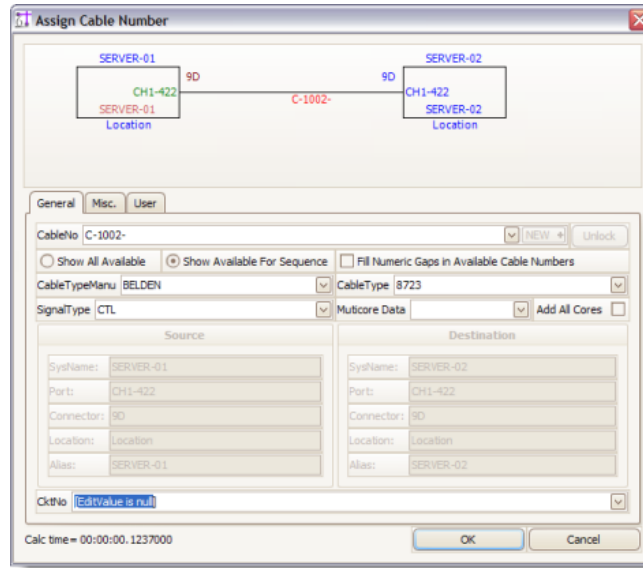

CableNo, New +, Unlock

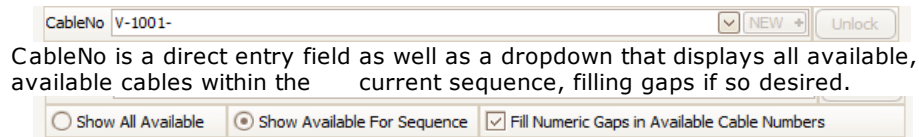

CableNo is a direct entry field as well as a dropdown that displays all available, available cables within the current sequence, filling gaps if so desired.

When double-clicking an assigned cable, the form will be shown in edit mode. The [Unlock] button will allow the cable number to be fully edited. This requires some caution. Be sure to check the database to be sure that the edits and deletions have been committed.

CableTypeManu, CableType



Select the Cable Type Manufacturer and Cable Type.

SignalType, Multicore Data, Add All Cores



Select the signal type.

If you have selected a multicore cable from the CableType dropdown, the core data will be shown. If you are assigning a single core in the core structure, select that core. If you wish to assign all cores and have selected enough cables to apply all core number to, select the Add All Cores checkbox.

Source and Destination info

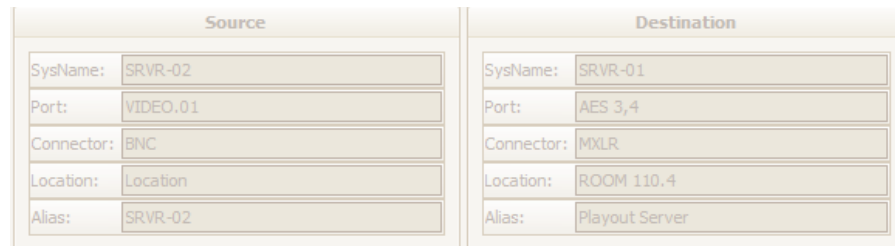

CktNo



Circuit Number

2.8 Assigning Terminals

Menu: **Advanced Tools>Equipment Functions>Assign Terminals**

Default command line shortcut: **ats**

Applies To:
All product levels
Related Settings:
None

Alternately: Double-click the terminal in the drawing
Assumes that at least one [SysName](#)^[36] has been assigned.

To assign multiple terminals at once, create a selection of like terminals. The order the terminals are added to the selection set is the order that they will be assigned numbers. Once you have created a selection of terminals, click: **Advanced Tools>Equipment Functions>Assign Terminal(s)**, or type **ats** into the command line followed by the **[Enter]** key.

This function performs the following steps:

1. Opens a port selection dialog based on SysName.
2. Prompts the user to select the SysName and the port or ports to display (or range of ports of multiple terminals are selected).
3. Updates the terminal(s) in the drawing.

Assign Terminal(s) Dialog

SysName

Select the SysName or press the **[+]** button to add a new SysName

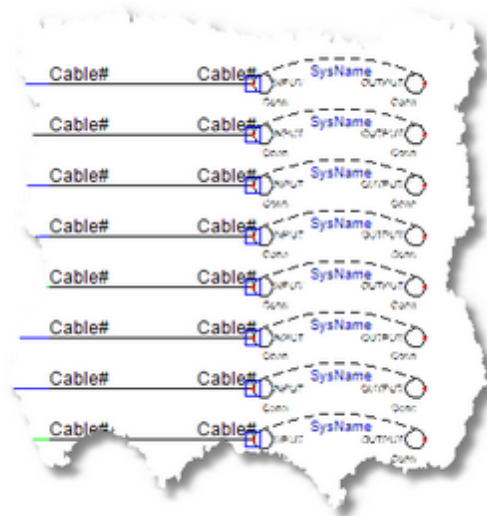

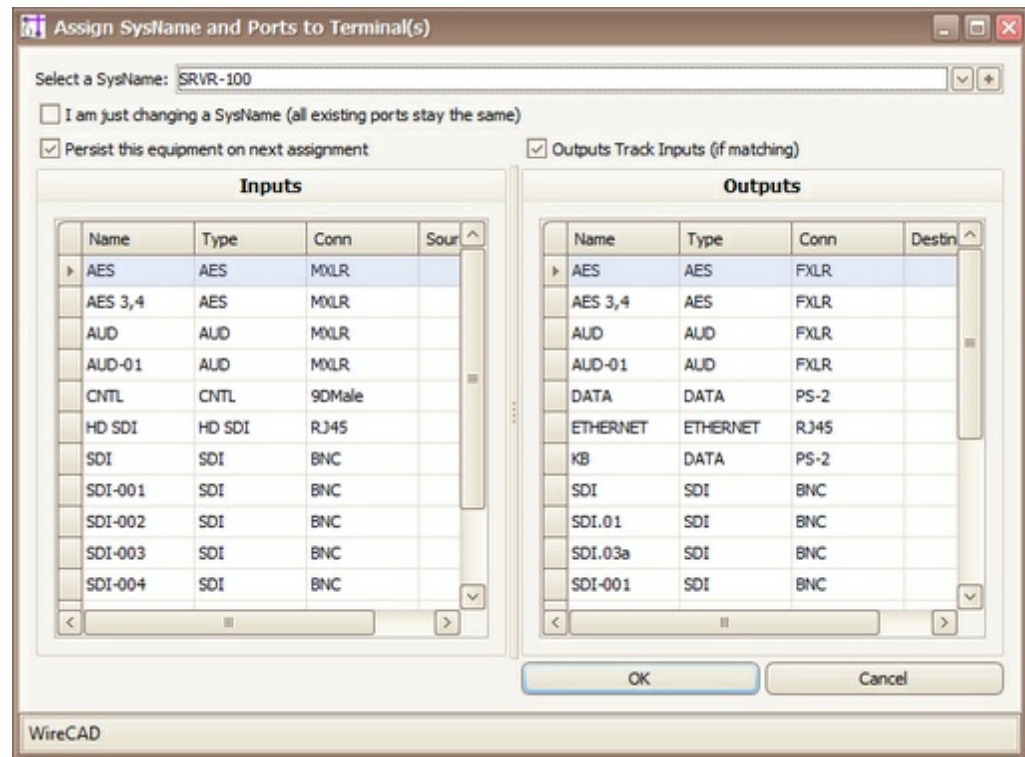

I am Just Changing a SysName

Persist this equipment

Outputs track inputs

Inputs grid

Outputs grid

Leaves all port data as currently displayed on a terminal, just changes the SysName. This is useful for modifying existing terminal assignments.

Remembers the selected SysName and returns to it on the next terminal assignment

When you select an input that has a corresponding output of the exact same name, that output will also be selected.

Active only if the selected terminal(s) have input connection points

Active only if the selected terminal(s) have output connection points

2.9 Rack Builder Tool

Menu: **Advanced Tools>Rack Functions>Rack Builder**

Default command line shortcut: **rb**

The Rack Builder tool is not available in XL Free mode

The Rack Builder tool utilizes information in the Project Systems table and the global equipment library to place and populate rack elevation views. This process may be run repeatedly as the project progresses.

Applies To:

XLT PRO

Related Settings:

[Default Rack Height](#)^[58]

[Top Down Racks](#)^[58]

Topics

[How it Works](#)^[42]

[Controls](#)^[43]

How it Works

The Rack Builder tool relies on three key pieces of information. First we need the SysName of the device to add to the rack. From the SysName we retrieve the equipment manufacturer and model. Second, using the equipment manufacturer and model, we get the global equipment definition from the global equipment database. If the global equipment definition is complete it will contain either a reference to a front panel dwg file (BlockRef) or dimensional data. If either of these are missing the Rack Builder tool will flag that equipment definition as requiring more information. The Rack Builder tool will perform a preflight check of all data and let you know what you are missing.

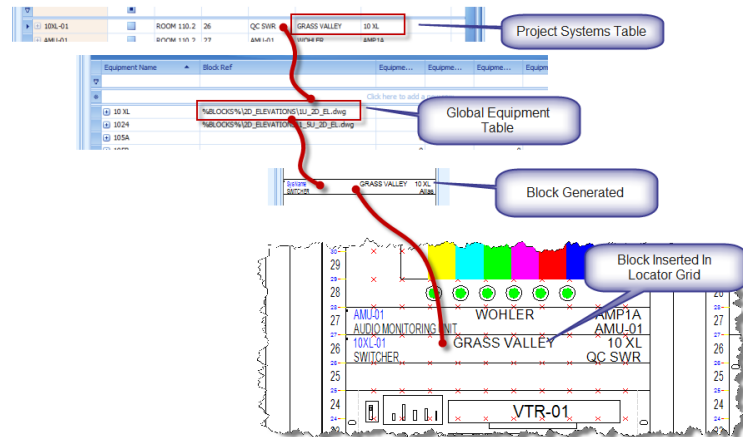

Assuming all of the data fiddly-bits are in the right place, the Rack Builder tool will populate the drawing with one locator grid per location selected. A locator grid is an array of point entities that are spaced horizontally and vertically based upon your selection in the preferences.

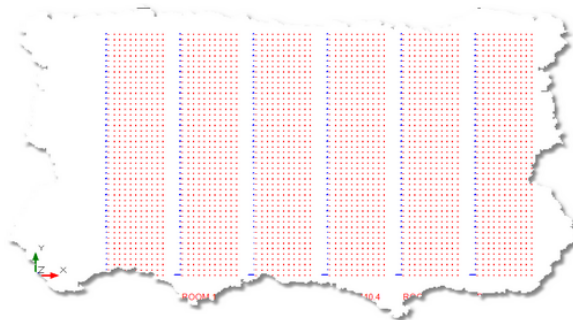

Next the Rack Builder tool, based on the Mechanical View Rule, will place either the front panel file or a block created from the dimensional data at the location point defined in the Project System entry.

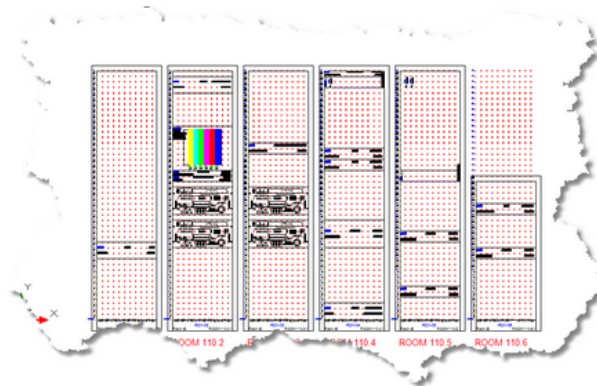

The locator grids facilitate location aware movement of the devices placed on the grid. You may manually place devices created from the equipment library in **Front Panel** mode on the locator grids.

To move a device within the rack elevations, select the device, grab it by its grip and move it to the desired location.

Note: It is desirable to turn on End Point snap and possibly Node Snap while moving devices

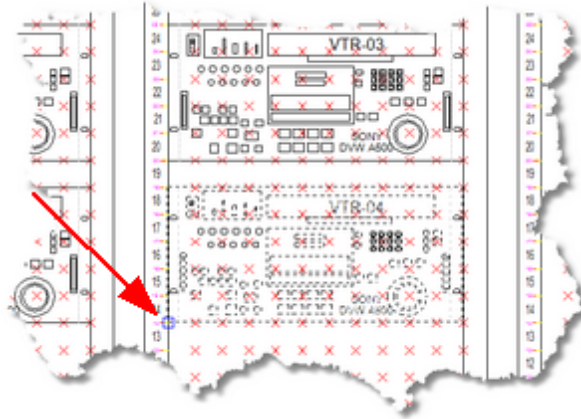

WireCAD will notify you of the location change and update the databases immediately to reflect the change.

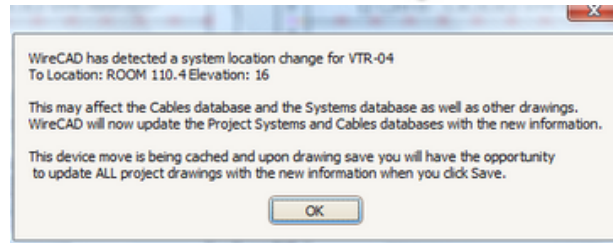

It will not update the remainder of the drawing set until you click save.

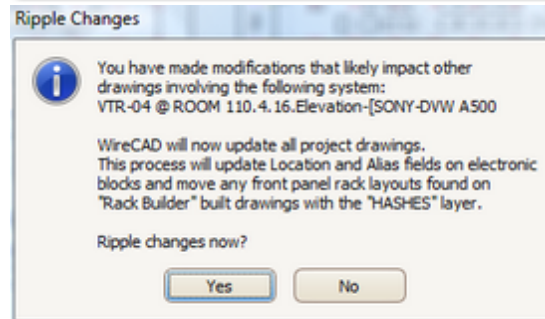

Once changes are made across the drawing set you will be notified of the changed drawings

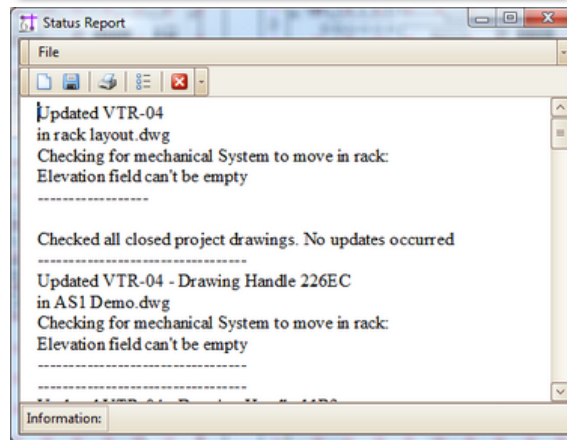

Controls

The **[Basic]** tab allows you to select the locations to include in the Rack Building function. Use the > >> and << selector buttons to move items from the left-hand list to the right-hand list.

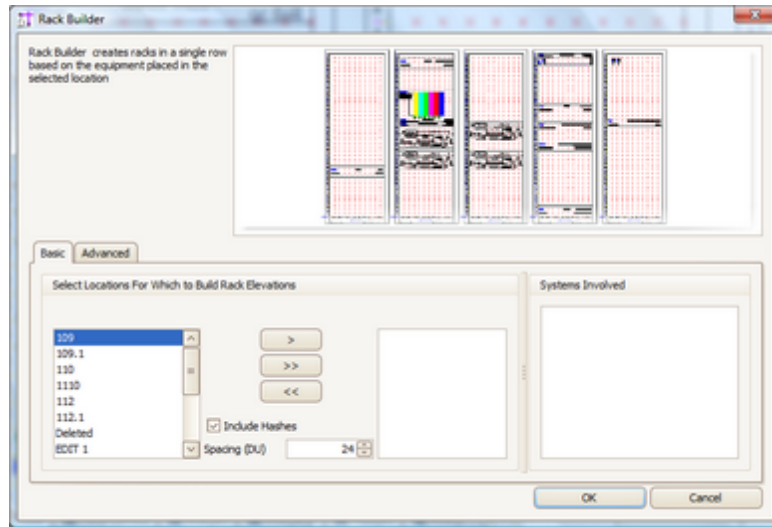

Include hashes

This will normally be checked unless you are rebuilding a drawing that already has the locator grids.

Spacing DU

Sets the location grid spacing in Drawing Units

Systems Involved list Displays a list of all the systems that will be placed in the created drawing.

The **[Advanced]** tab exposes properties that control the behavior of the utility.

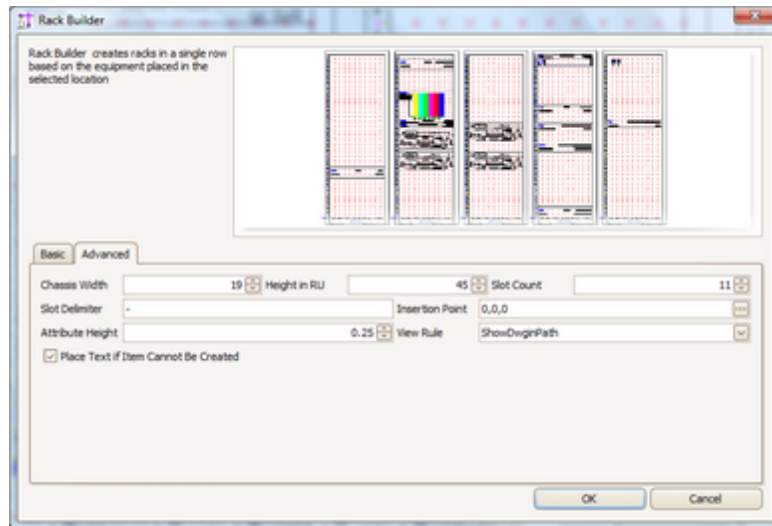

Chassis Width

Sets the width of the chassis in DU

Height in RU

Sets the height of the locator grid in Rack Units (RU = 1.75 inches or 4.445cm)

Slot Count

Sets the number of slots per locator grid. This is used to position items that may not be located at the insertion point of the rack unit.

Slot Delimiter

WireCAD searches the Elevation field for numeric values first then for the slot delimiter if found it parses the the data into two values the elevation and the slot, or in other words how far up in the rack and how far over.

Insertion Point

Where to start the whole process

Attribute Height

If view rule is not ShowDWGInPath, sets the attribute height of the displayed text.

View Rule

ShowDWGInPath = use the dwg file found in the equipment definition **BlockRef**.

CreateFromDimensions = use the dimension data from the equipment definition to create a 3D rack block.

CreateFromDimensionsIfNotFound = Use dimension data if the **BlockRef** is not found.

Place Text If Item Cannot Be Created

If the item cannot be created due to lacking data, place a text marker in the drawing at the location.

2.10 AutoScheme Tools

The AutoScheme tools create functional drawings or parts thereof from the data in the project systems and cables databases. This is useful to create detail or overall views.

The AutoScheme tools consist of two utilities. The Auto Block tool automatically places blocks in the drawing on a grid. The RatsNest tool checks the project cables database against the drawing. If connections defined in the cables database can be reproduced in the drawing because the SysNames and Ports exist, a cable is placed.

[Auto Block](#)^[46]

[RatsNest](#)^[47]

Auto Blocked drawing. Blocks have been created and placed.

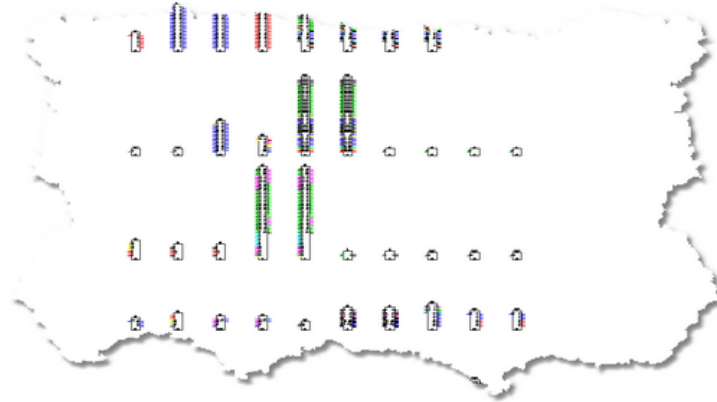

After running the RatsNest tool. This supplies the drawing with cable data and provides a positional reference to help you decide where to move block to better display the drawing.

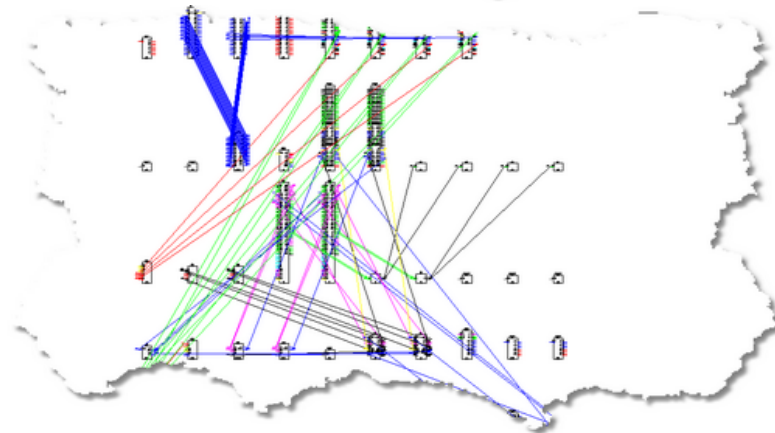

After running the Cleanup tool from the RatsNest utility.

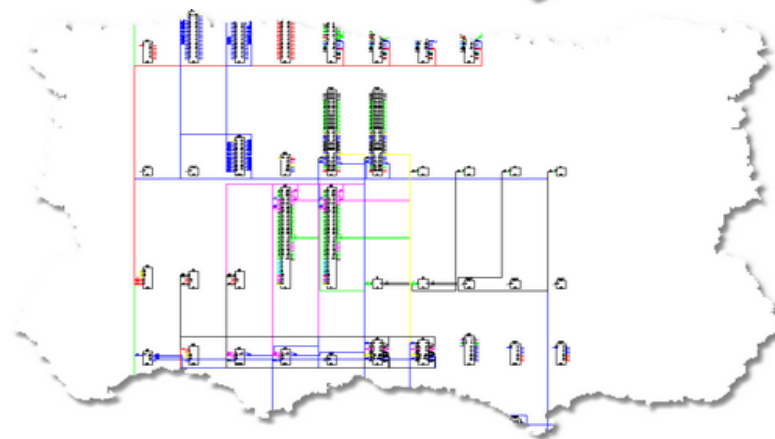

[****](#)^[46]

2.10.1 Auto Block

Menu: **Advanced Tools>AutoScheme Tools>Auto Block**

Default command line shortcut: **ab**

Applies To:
PRO
Related Settings:
None

The Auto Block tool automatically places functional blocks in the drawing. This tool requires that the Project Systems table be populated.

Controls

The **[Basic]** tab allows you to use the >> and << selector buttons to determine which systems to add to the drawing.

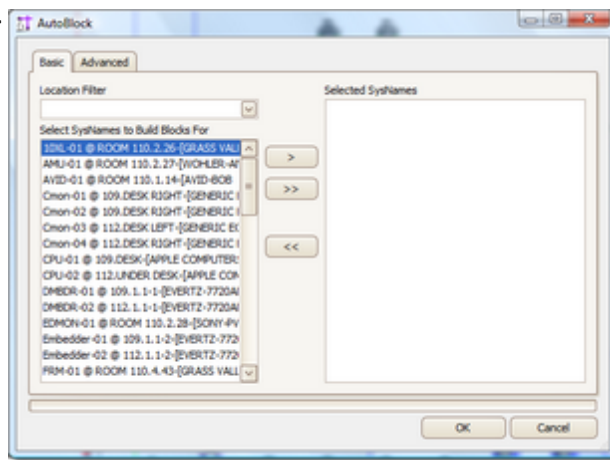

Location Filter

Filters the left-hand list by location

The **[Advanced]** tab allows you to refine the behavior of the utility.

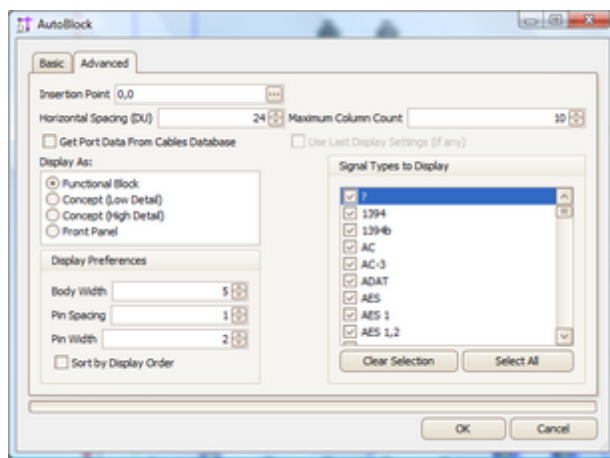

Insertion Point Horizontal Spacing DU

The point we start from.
How far apart horizontally. The vertical spacing is defined by the height of the highest block in the row.

Maximum Column Count Get Port Data From Cables Database

How many columns horizontally
Select this option to search the cables database for port info instead of the global equipment database. This will effectively show only those ports to which we have attached cables.

Display As Display Preferences

How to display the blocks
If Functional Block or Concept block is selected then set basic display parameters.

Signal Types to Display

Filter ports by the selected signal types.

2.10.2 RatsNest

Menu: **Advanced Tools>AutoScheme Tools>RatsNest**

Default command line shortcut: **rn**

Applies To:
PRO
Related Settings:
None

The RatsNest tool checks the project cables database against the drawing. If connections defined in the cables database can be reproduced in the drawing because the SysNames and Ports exist, a cable is placed.

This tool requires that the Project Cables table be populated.

Controls

This tool has three sections. The Rats Nest section does the work of placing the cables in the drawing as defined in the Cables database.

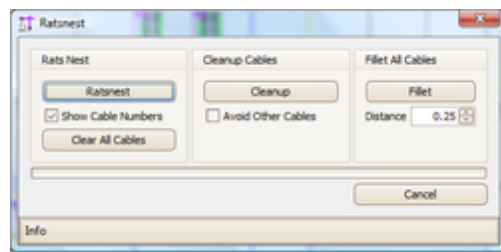

[Ratsnest]
Show Cable Numbers
[Clear All Cables]

Run the utility to place the cables.
With or without cable numbers.
Removes **ALL** cables from the drawing.

[Cleanup]
Avoid Other Cables

Applies the autorouter to all cables in the drawing.
Autorouter avoids other cables on cleanup.

[Fillet]
Distance

applies fillets to all cables in the drawing
fillet distance in DU.

2.11 System Snapshot

Menu: **Advanced Tools>Equipment Functions>System Snapshot**

Default command line shortcut: **ss**

Applies To:
PRO
Related Settings:
None

The System Snapshot tool utilizes information in the Project Systems table and the Global Equipment Library and the Project Cables database to create a view of all cables attached to the selected SysName.

These details are useful for error checking and in the field as an installation aid.

Controls

The System Snapshot dialog

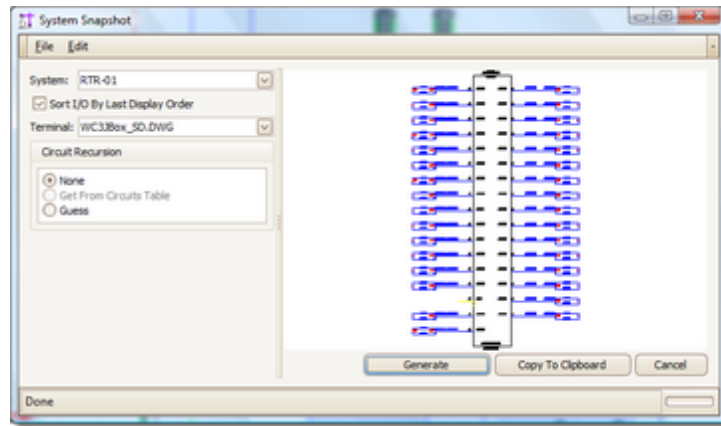

System
Sort I/O By Last Display Order
Terminal

The SysName to snapshot
The last display order defined in the equipment library

The terminal to display

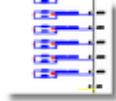

Circuit Recursion

None = disabled

Get From Circuits Table = Not yet implemented

Guess = search for either a direct string match on the corresponding I/O or a numeric match of the same signal type.

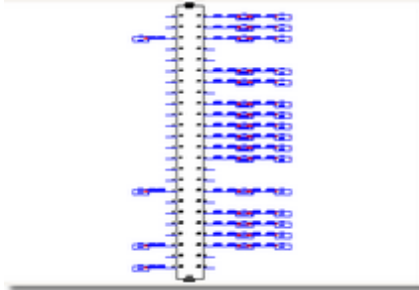

[Generate]
[Copy to Clipboard]

Do It!

Copies the snapshot to the clipboard for pasting into another drawing.

Part

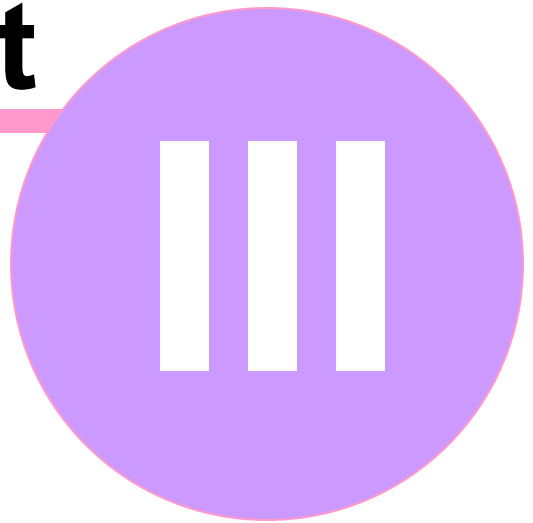

3 Personalizing WireCAD

- [The Settings Dialog](#) ^[50]
- [Setting the Skin](#) ^[60]
- [Template Drawings](#) ^[62]

3.1 The Settings Dialog

Menu: **Project>Settings**

Default command line shortcut: **set**

Applies To:
All
Related Settings:
None

The settings dialog hosts panels for several different settings levels:

- Application** Setting occurs once per application install per machine.
- User** Setting specific to the current user.
- Project** Setting specific to the current project if any.

The following is a listing of the default panels. If your organization is using WireCAD Security your user will require Administrator privileges in order to edit Application level setting and some Project level settings. The may be a partial listing depending on the plugins loaded.

Application Settings Panels

Basic

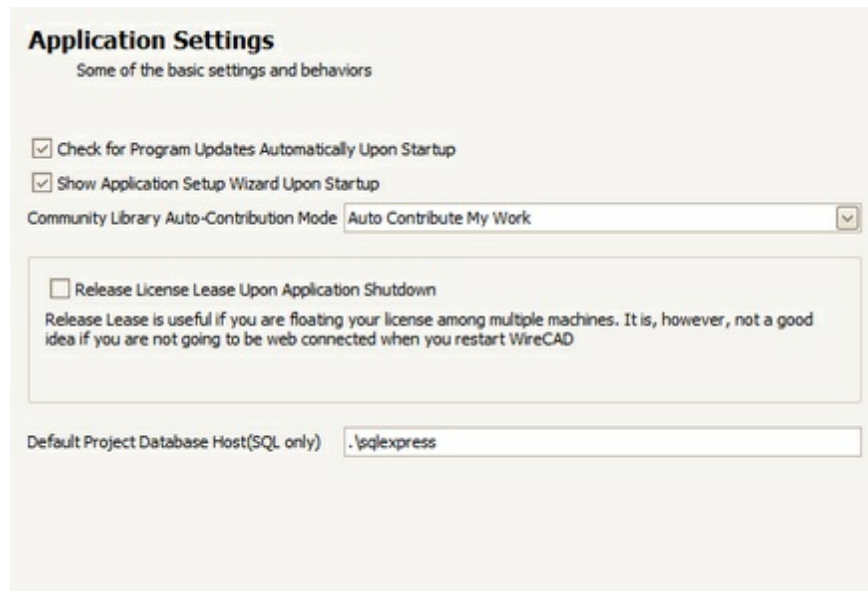

- Check for Updates**
- Show Application Setup Wizard**
- Community Library Auto-Contribute Mode**
- Release Lease On Shutdown**
- Default Project Database Host**

Checks for new updates to the application on application startup
Shows the Application Setup Wizard which walks you through the basics of setting up the Application level settings on startup.
Your Equipment Library will be automatically contributed to the WireCAD community unless you otherwise.
If you are [floating your license](#) ^[5] you will want to set this to true unless you plan to start WireCAD while you are not web connected.
Applies only to SQL projects. Presets the New Project Wizard

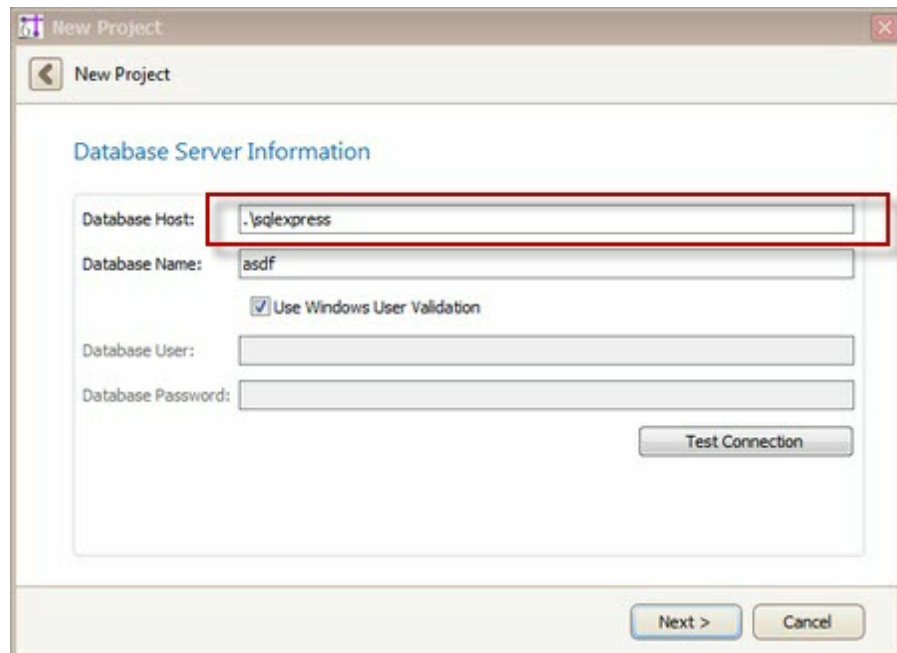

WireCAD Security

This is typically set via the Application Setup Wizard.

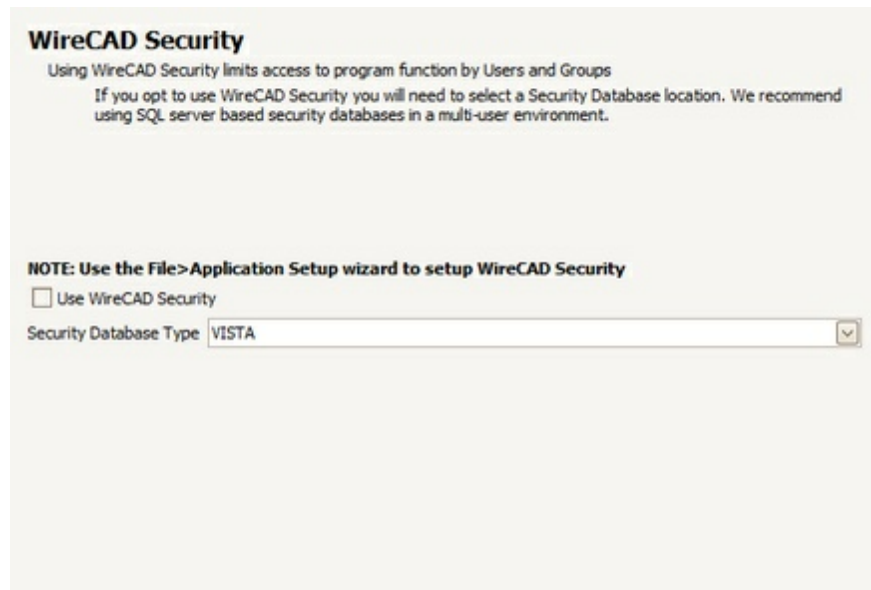

Use WireCAD Security

Enable Security. When enabled the WireCAD security system uses the current login to determine program access. If your user is a member of the Administrators group you will be able to control access of other users via the **Project>Security>Manage Security...** dialog.

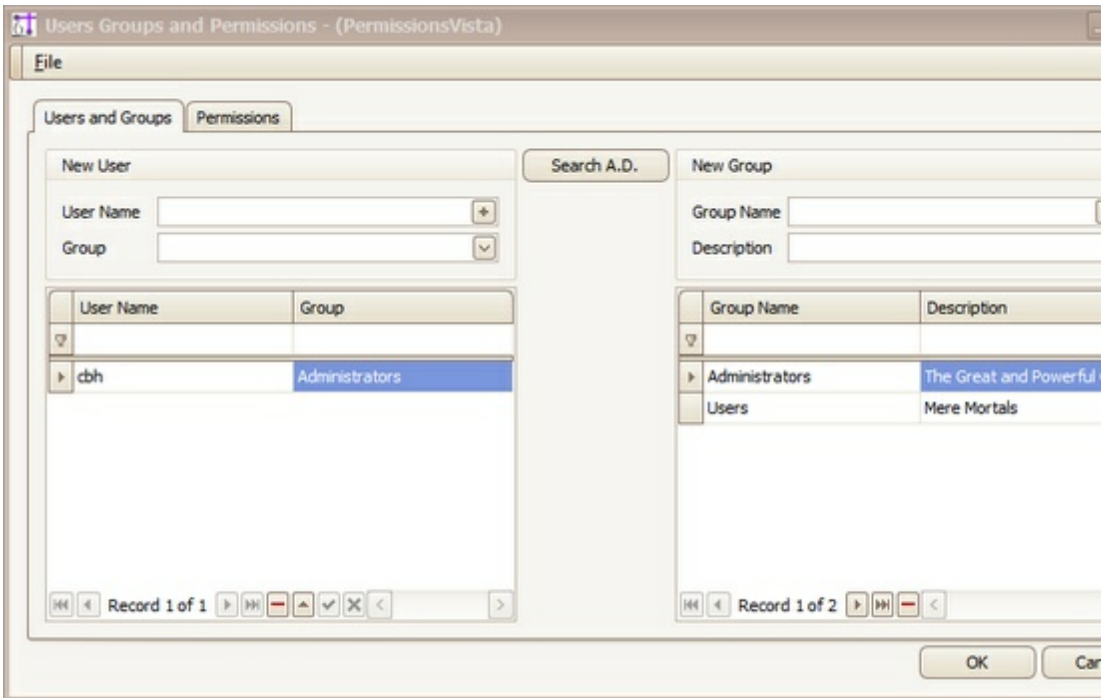

Security Database Type Typically you will only use security in a multiuser environment with a SQL host, but the capability to use file based VistaDB databases.

Support Paths Panel

Support Paths

The support paths allow us to substitute actual paths for variables and simply reroute locations to key files and folders.

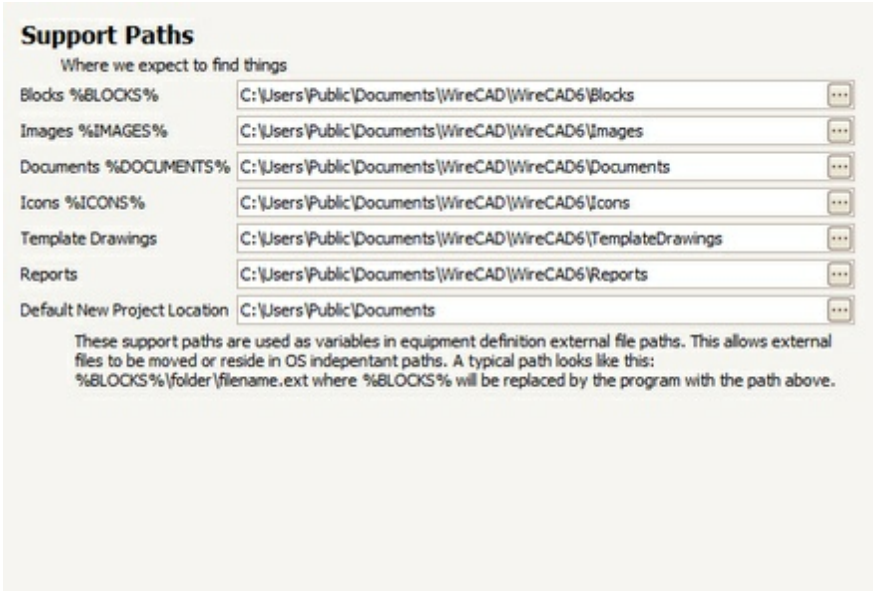

All Support Paths Can Reside on Network Shares and Use UNC Naming Conventions.

- Blocks**
- Images**
- Documents**
- Icons**

The path that will replace the %BLOCKS% variable in the equipment library.
 The path that will replace the %IMAGES% variable in the equipment library.
 The path that will replace the %DOCUMENTS% variable in the equipment library.
 The path that will replace the %ICONS% variable in the equipment library.

Template Drawings

The path to the Template Drawings folder. This is the folder where Template Drawings are saved using the **File>Save As Template Drawing** function is used and the folder that the New Drawing Wizard searches to file the Templates list:

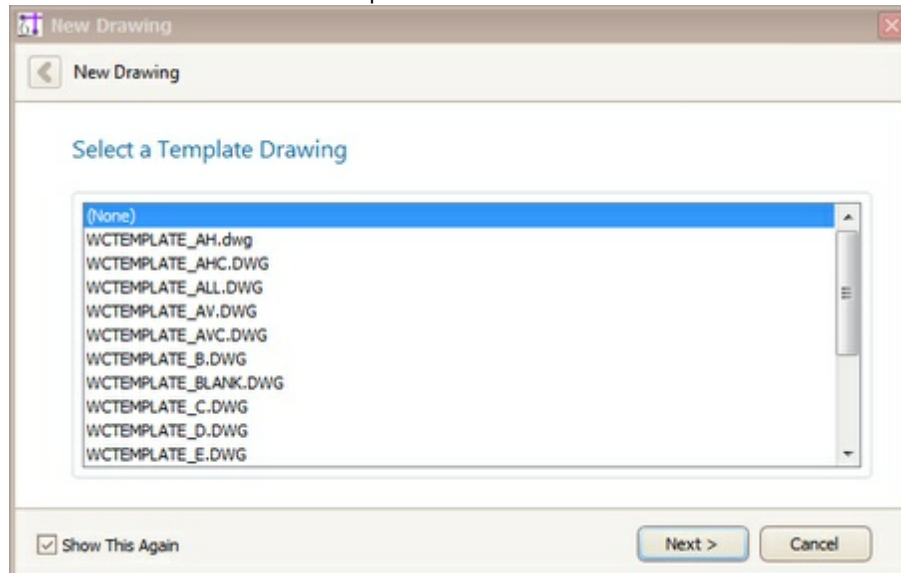

Reports Default New Project Location

The path to top reports folder. This is a recursive search and will enumerate all subfolders and files. Presets the New Project Wizard.

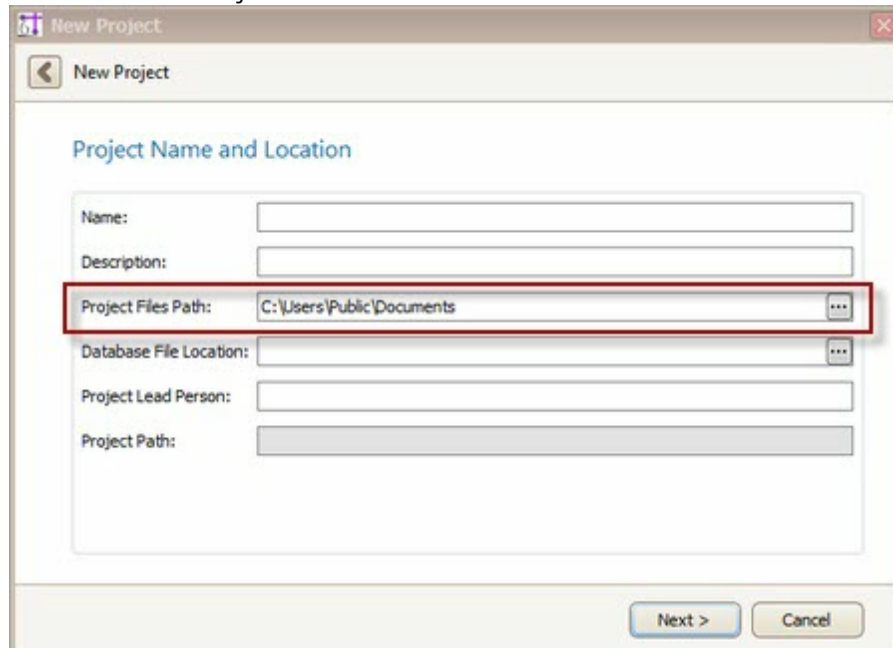

Organization

Your organization details.
Used by many of the plugins.

Organization Info

The settings are used in some of the plugins. For an example, see the Title Block Filler plugin

Company Name	WireCAD
Address1	4280 E. Amity Ave.
Address2	Suite 101
City	Nampa
State/Region	ID
Postal Code	83687
Country	USA
Phone	+1 661.253.4370
Fax	+1 208.468.8797
Web Address	www.wirecad.com

User Settings Panels

Basic

User Settings

Customize It For You

Skin Name

- Open New Drawing Upon Application Startup
- Use the New Drawing Wizard When Creating a New Drawing
- Open My Last Project When I Start WireCAD
- Show the WireCAD Startup Page When I Start WireCAD
- Warn Me When I Mismatch a Signal Type While Drawing Cables
- When I Double-click a Many-to-Many Cable Assign All of Them
- Keep My Equipment Library Open After I Add Equipment to the Drawing (Only Works on Dual Monitors)
- When I Link Pointers Go Back to the Starting Drawing When Finished

Library Multiple Port Add Leading Zero Count

Only applies to newly created ports. This setting presets the Add Port Dialog.

Skin Name
Open New Drawing Upon Application Startup

Change the skin (appearance).
Opens a blank new drawing when WireCAD starts.

Use the New Drawing Wizard

Shows the [New Drawing Wizard](#) when you click File>New.

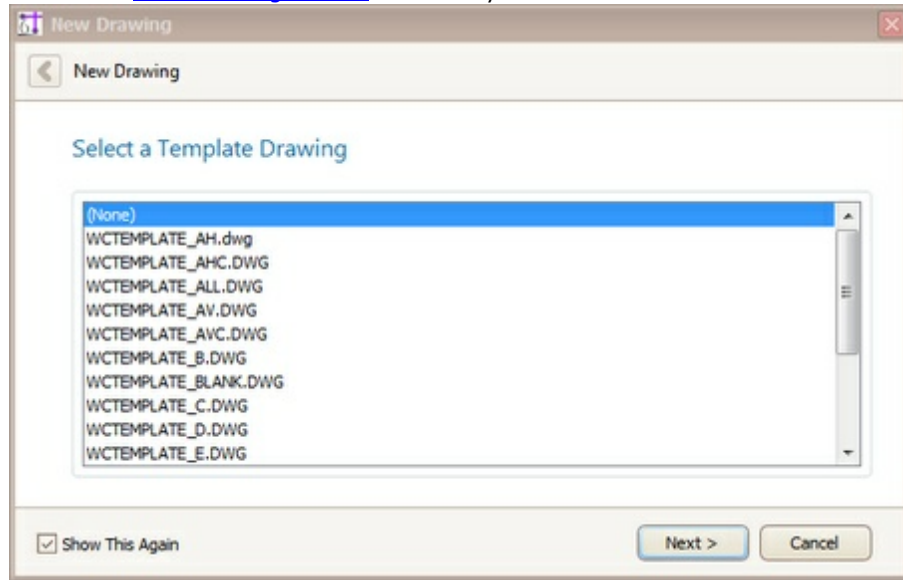

Open Last Project When I Start WireCAD Show the WireCAD Startup Page

Allows the use of template drawings. If set to false, just creates a new drawing without a template. Behaves like earlier versions of WireCAD that opened the last project automatically on startup.

The WireCAD Startup Page shows the latest news from the WireCAD ranch.

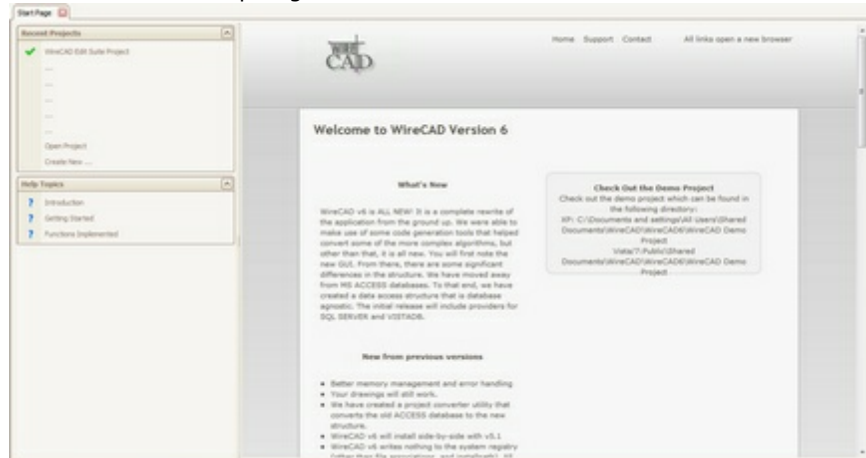

Warn Me When I Mismatch a Signal Type

When you finish drawing a cable WireCAD will check the source and destination port signal types and you know if they don't match.

You can use the new status panel to know the port type if you are confused.

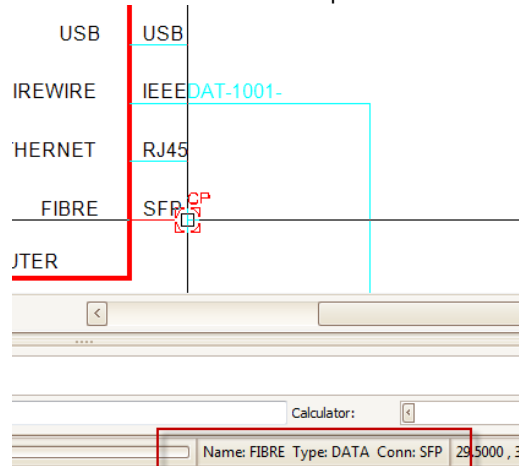

When I Double-click a Many-to-Many Cable Assign All of Them Keep My Equipment Library Open When I Link Pointers Go Back Library Multiple Port Add Leading Zero Count

[Many-to-Many cables](#)^[33] that are set for Multiple Database Entries can either be assigned all at once with a single double-click, or if this setting is turned off a double-click will find the closest port to the cursor and assign that. This is useful if you are using dual monitors and want to have the Equipment Library stay open on one monitor and the other monitor. The default Link Pointer function will leave you on the second sheet. If you set this to true it will jump you back to the first sheet. Presets the Port Adder Dialog

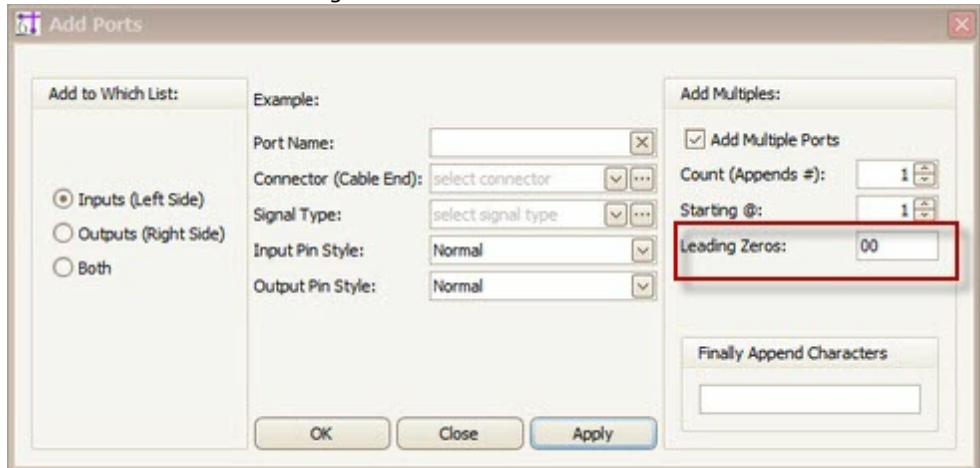

Drawing Settings Panel

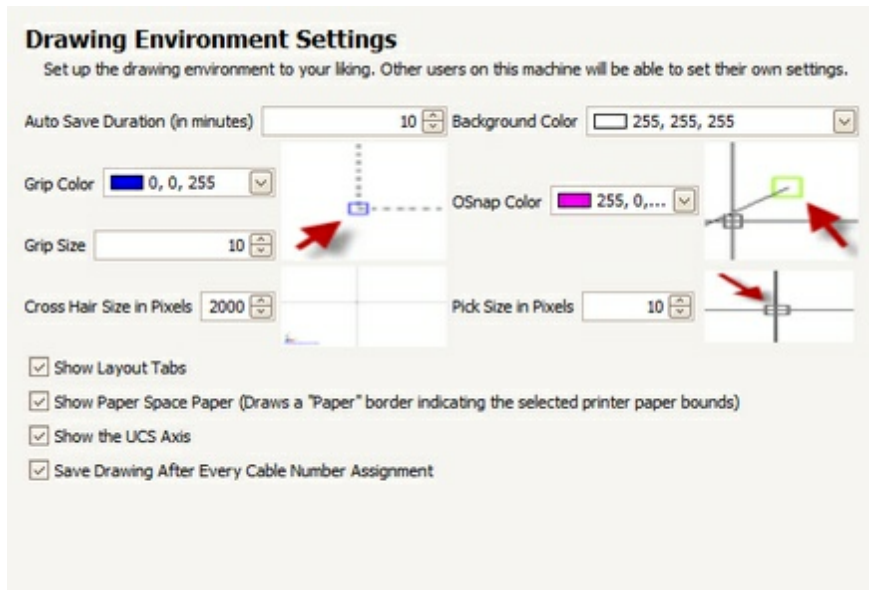

Auto Save Duration in Minutes
Background Color
Grip Color
OSnap Color
Grip Size
Pick Size
Cross Hair Size
Show Layout Tabs

Sets the Auto Save Duration. Auto Save saves only drawings that are not currently involved in a function.
 Sets the background color.
 Sets the grip color.
 Sets the Object Snap Color.
 Sets the grip size in pixels.
 Sets the pick size in pixels. The pick determines the search window when clicking the cursor.
 Sets the cross hair size in pixels.
 Shows the layout tabs at the bottom of the drawing frame



Show Paper Space Paper When a layout is selected, show the current page size as returned by the selected printer as a "page."

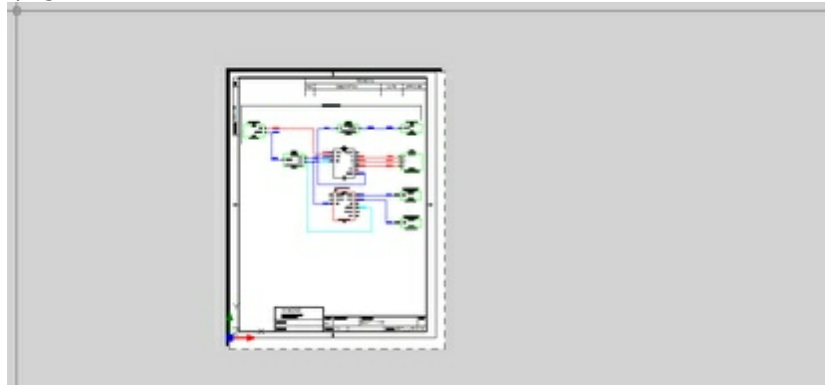

true

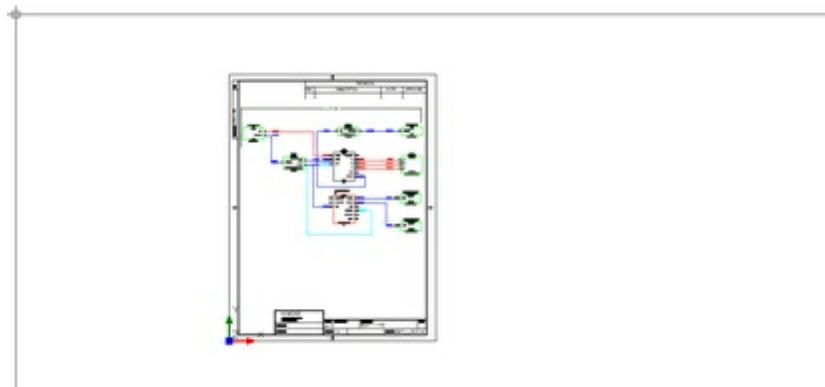

false

Show UCS Axis

Shows the UCS Axis



Save Drawing After Every Cable Number Assignment Setting this to true is not recommended but will speed the assignment process.

Cable Number Assignment

You are responsible then for saving the drawing to ensure drawing/database parity.

Command Line Shortcuts

Execute a command by typing either Command Name, Alias, or Shortcut.

Command Na...	Alias	ShortCut	Assembly	NameSpac...	MethodName
▶ About					About
Activate Viewport					ActivateViewport
Add Attribute	AddAttribute	att	VectorDraw.P...	VectorDraw.P...	AddAttributeEx
Add Cable Jumps		aj			AddCableJumps
AddEditPluginInfo					AddEditPluginInfo
Add Vertex		av			AddVertex
My Cool Functio...		mcf2	ProjectExplor...	ProjectExplor...	AMethodWithE...
Arc	Arc	a	VectorDraw.P...	VectorDraw.P...	ArcEx
Area		aa			Area
Assign Cable Nu...		ac			AssignCableNu...
AssignSysName		as			AssignSysName
AssignTerminal		at			AssignTerminal
AssignTerminals		ats			AssignTerminals
AutoBlock		ab			AutoBlock
AutoSave All					AutoSaveAll

Register Your Own Command Remove Command [Click to Check for Warnings](#) Check

User Settings Panels

Project Settings

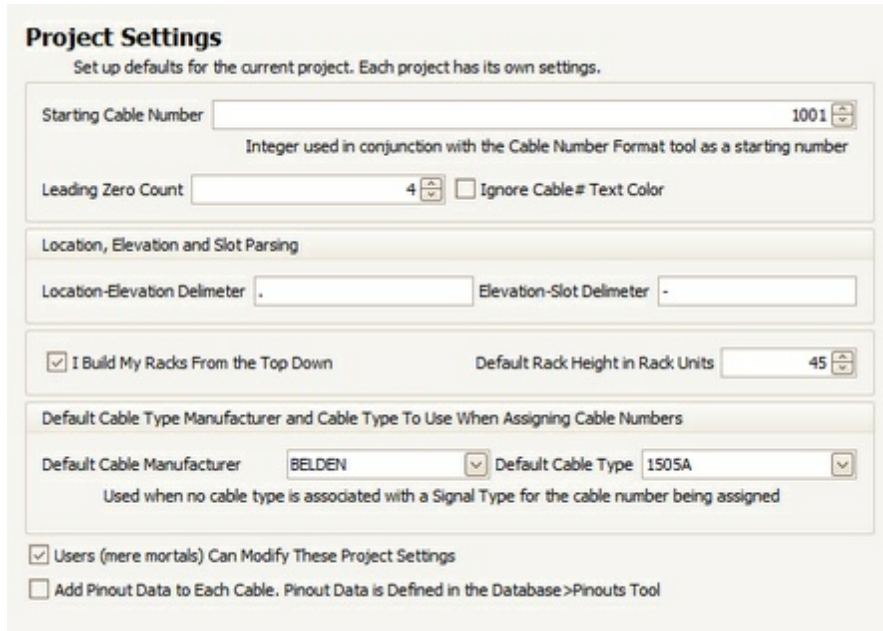

Project Settings
Set up defaults for the current project. Each project has its own settings.

Starting Cable Number Integer used in conjunction with the Cable Number Format tool as a starting number

Leading Zero Count Ignore Cable# Text Color

Location, Elevation and Slot Parsing

Location-Elevation Delimiter Elevation-Slot Delimiter

I Build My Racks From the Top Down Default Rack Height in Rack Units

Default Cable Type Manufacturer and Cable Type To Use When Assigning Cable Numbers

Default Cable Manufacturer Default Cable Type
Used when no cable type is associated with a Signal Type for the cable number being assigned

Users (mere mortals) Can Modify These Project Settings

Add Pinout Data to Each Cable. Pinout Data is Defined in the Database > Pinouts Tool

starting cable number

This will be the starting number for any new sequence. It is overridden by a range in the Signal Type global database.

leading zero count

Leading zeros for cable numbers. Affected by the [Project Cable Number Format](#).

ignore cable# text color

True to set the Cable# text entity PenColor = ByLayer.

Location-Elevation Delimiter

By default this is a "." When the Location and Elevation fields are combined in the drawing this will be concatenated with the Location-Elevation Delimiter. Example: Location: Rack-10 Elevation 10 would be concatenated with the Location-Elevation Delimiter as follows: Rack-10.10

Elevation-Slot Delimiter

By default this is a "-" When parsing the elevation field this variable is used to identify a slot. Example: Elevation 10 slot 4 would be 10-4.

I Build My Racks From the Top Down

Numbers from top down. The default is bottom up.

Default Rack Height

Default Rack Height in Rack Units. Presets the [Rack Builder](#) ^[41] dialog.

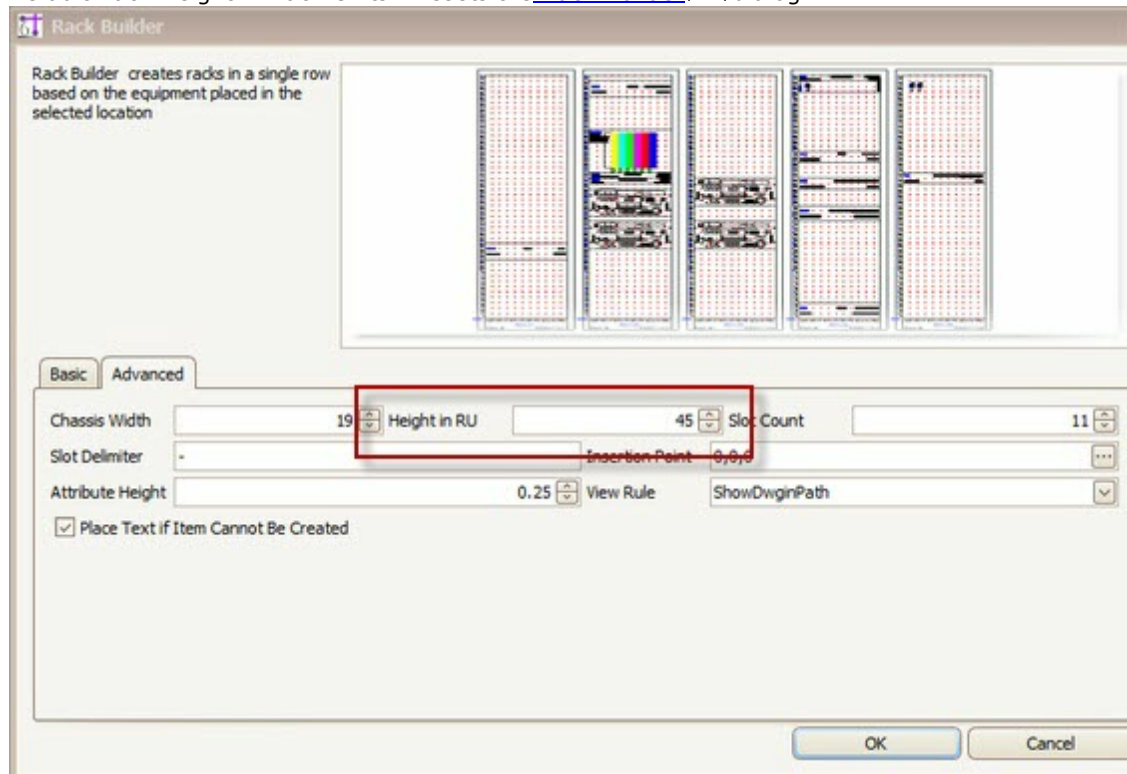

Default Cable Manu and Type
User Can Modify These Settings

If the Signal Type in the global database does not define a default Cable Type and Manufacturer then this is used as a default.
 Only effective under WireCAD Security

Add Pinout Data to Each Cable

Set to true to allow attachment of pinout data to each cable. You must display the Edit Cable Data in order to pick the pinout. Pinouts are set using the [Pinouts plugin](#). Once defined, during a cable number assignment you can pick from pinouts that have the proper connectors defined. If the proper connectors, both src and dst, do not exist in the pinout it will not be available for choice.

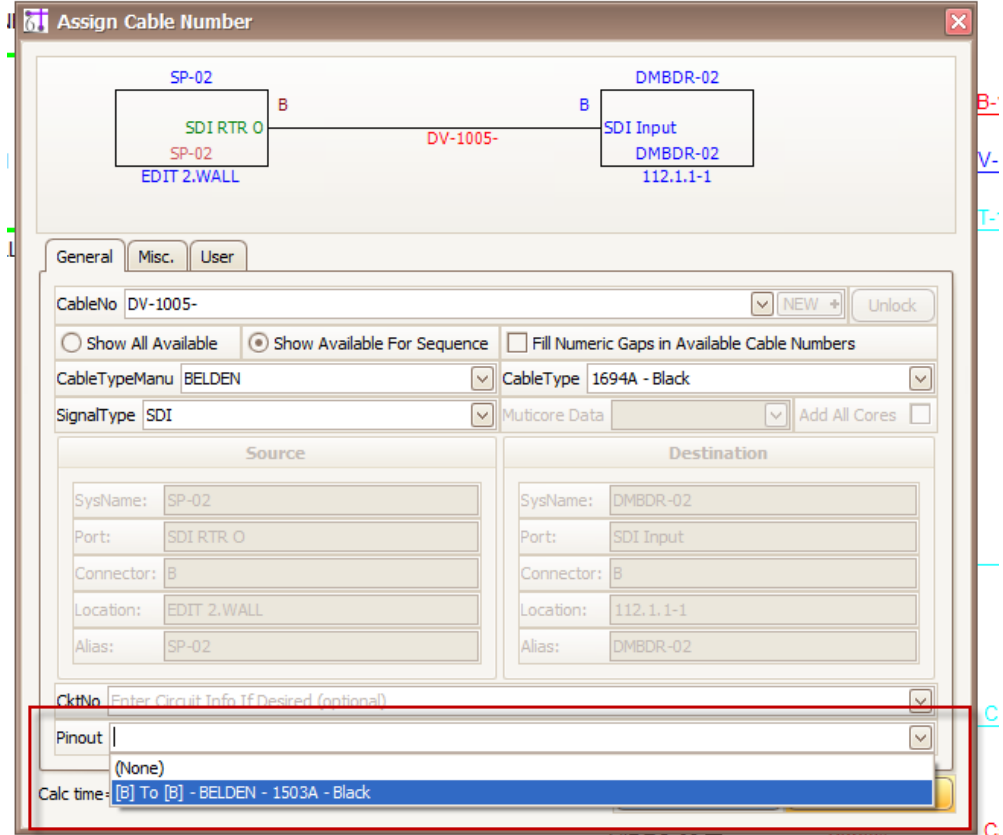

3.2 Setting the Skin

Menu: **View>Skin** or **Project>Settings[User Basic] Skin**

Default command line shortcut: **set**

Applies To:
All
Related Settings:
None

WireCAD ships with a number of custom skins. Play with them until you find one that suits you. Some of them are very functional while others are quite whimsical.

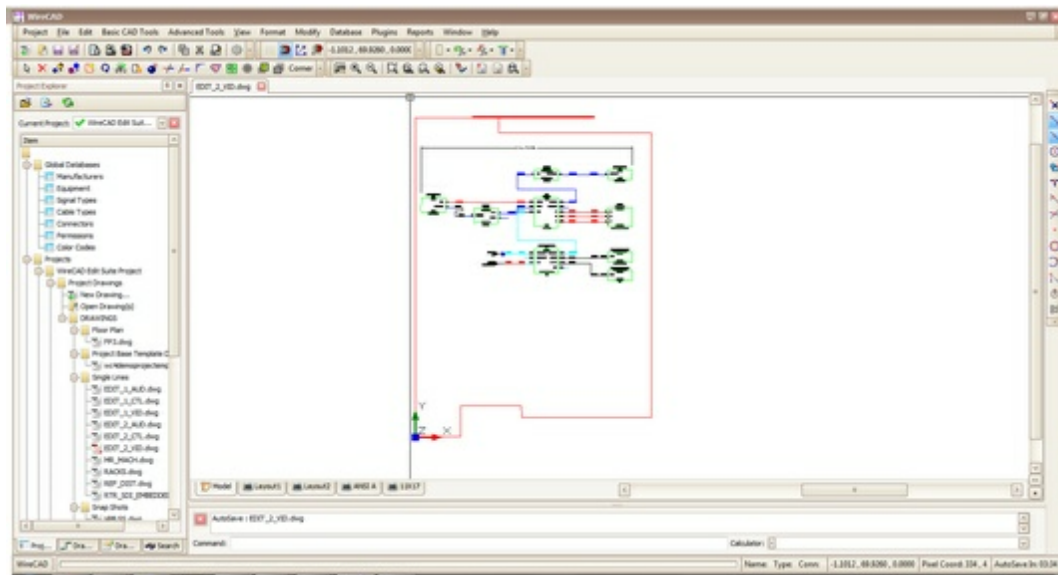

Caramel

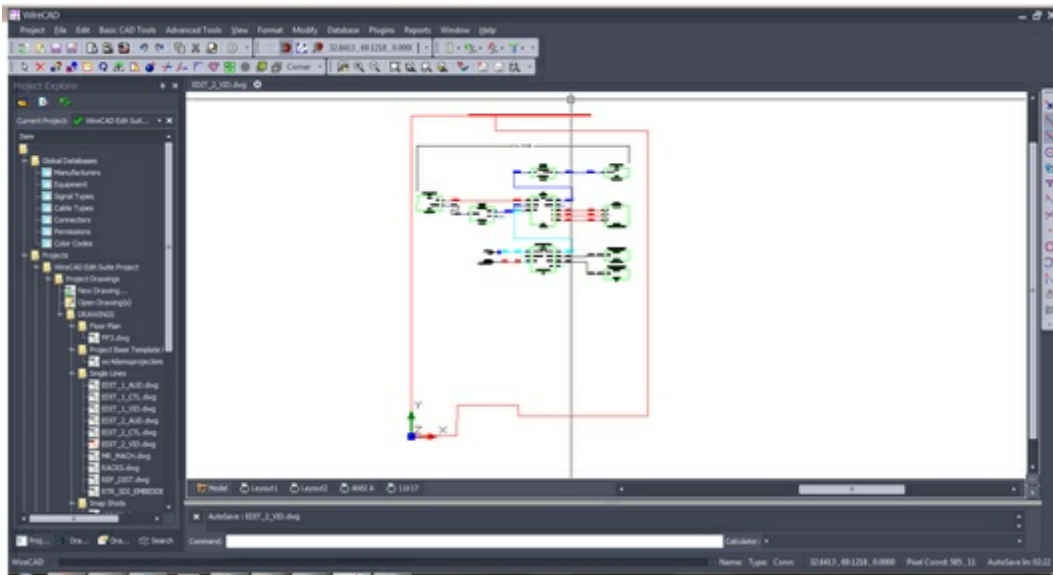

sharp plus

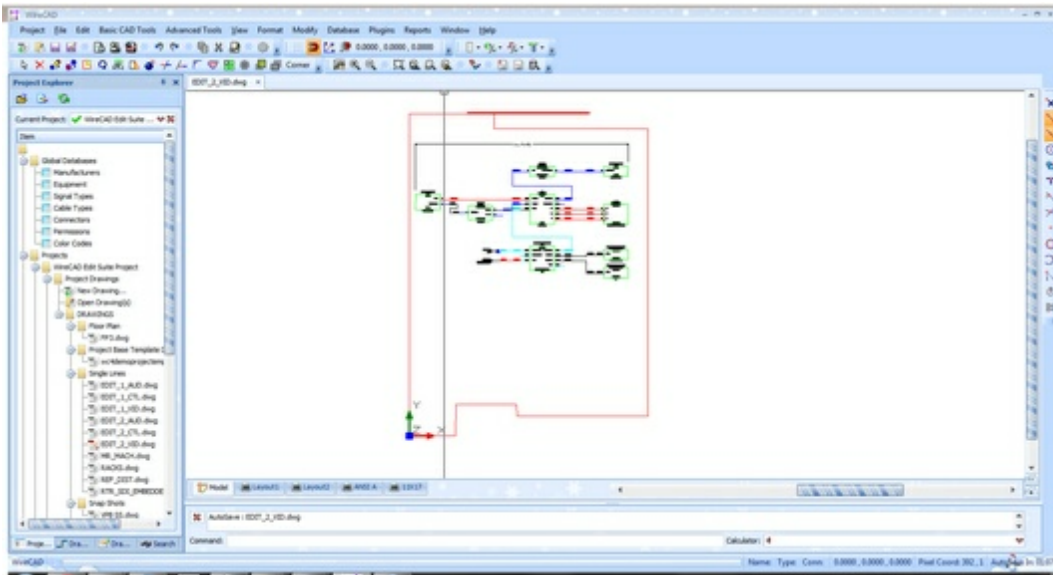

Xmas

3.3 Template Drawings

Menu: **File>Save As Template Drawing**

Menu: **File>Open Drawing**

Default command line shortcut: **fo (File Open)**

Applies To:

All

Related Settings:

[Show New Drawing Wizard](#)^[55]

[Template Drawings Support Path](#)

^[52]

Template drawings are drawings that are preset with items that you don't want to add every time, such as page borders (titleblocks) and [viewports](#)^[14]. It is not uncommon to create a template for each project by starting with an existing drawing and adding your titleblock data etc. Some WireCAD users go so far as to create templates for their frequently used designs.

Template drawings are saved in the [Template Drawings Support Path](#)^[52]. You can pick template drawings from the New Drawing Wizard.

Part



4 Reporting

Contents

[Printing Reports](#) ⁶⁵

[Filtering Reports](#) ⁶⁶

[Creating Reports](#) ⁶⁸

4.1 Printing Reports

Menu: **Reports>Report**, Alternately: double-click the report in the **Project Explorer**

Default command line shortcut:

Opens a report for preview, printing or export

Applies To:

XLT PRO

Related Settings:

None

Reports display in design view by default (XL mode excepted).

The top screenshot shows the report design view. It features a design grid with callouts for various components: 'Tools' (a callout pointing to the left toolbar), 'Datasource' (a callout pointing to the data source configuration), 'Detail (repeats for every record)' (a callout pointing to a table row), 'Property Window' (a callout pointing to the right-hand property pane), and 'Preview Button' (a callout pointing to the 'Preview' button at the bottom of the design view).

The bottom screenshot shows the report preview in 'Cable Run Sheet' format. It includes a 'Parameters' pane on the left with fields for 'Cable No Min', 'Cable No Max', 'Available', and 'Title'. The main preview area displays a table with the following data:

Number	Source			Conn	Location	Destination	
	Source	Alias	Location			Alias	
2143-1234-2134	SRVR-02 > VIDE0.01	SRVR-02	BNC	Location	SRVR-01>RS-422	Playout	
A-1001	VTR-01 > MON-L	VTR-01	X	ROOM 110.2.20	10XL-01-R1	QC SW	
A-1002	VTR-01 > MON-R	VTR-01	X	ROOM 110.2.20	10XL-01-R1	QC SW	
A-1003	VTR-02 > MON-L	VTR-02	X	ROOM 110.2.14	10XL-01-R2	QC SW	
A-1004	VTR-02 > MON-R	VTR-02	X	ROOM 110.2.14	10XL-01-R2	QC SW	
A-1005	VTR-03 > MON-L	VTR-03	X	ROOM 110.3.22	10XL-01-R3	QC SW	
A-1006	VTR-03 > MON-R	VTR-03	X	ROOM 110.3.22	10XL-01-R3	QC SW	

Callouts in the bottom screenshot include 'Print' (pointing to the 'Print' button), 'Export' (pointing to the 'Export' button), and 'Parameter Pane (if the report uses parameters)' (pointing to the 'Parameters' pane).

Clicking the **[Preview]** button renders the report unless the report defines parameters that the user must enter followed by the **[Submit]** button on the parameter pane.

4.2 Filtering Reports

Menu: **Reports>Report**, Alternately: double-click the report in the **Project Explorer**

Applies To:
XLT PRO
Related Settings:
None

Default command line shortcut:

Report filtering is not available in XL free mode.

In order to filter a report the report must be in design mode

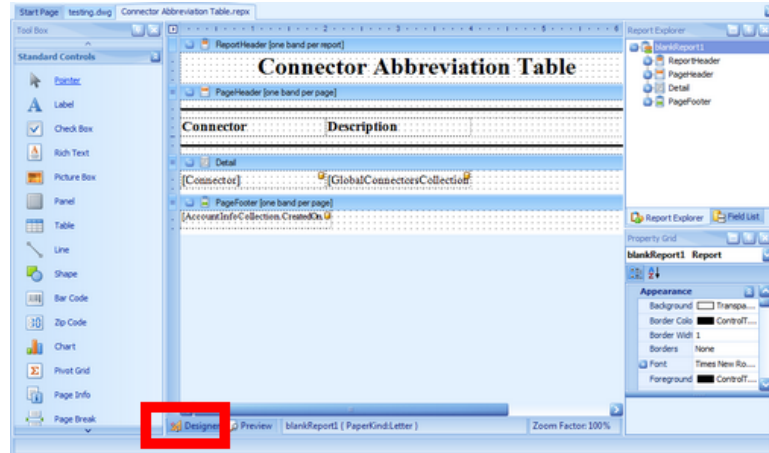

Make sure that the Property window is displayed. If not click:

View>Windows>Property Grid

From the Property grid object

selector, select XRReport1

From the Property grid select the

Filter String ... ellipsis button

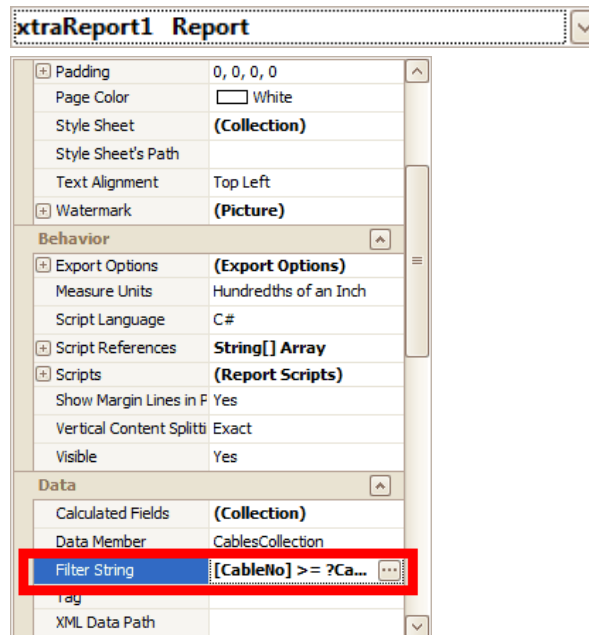

This opens the filter dialog from which you may select a number of different filters

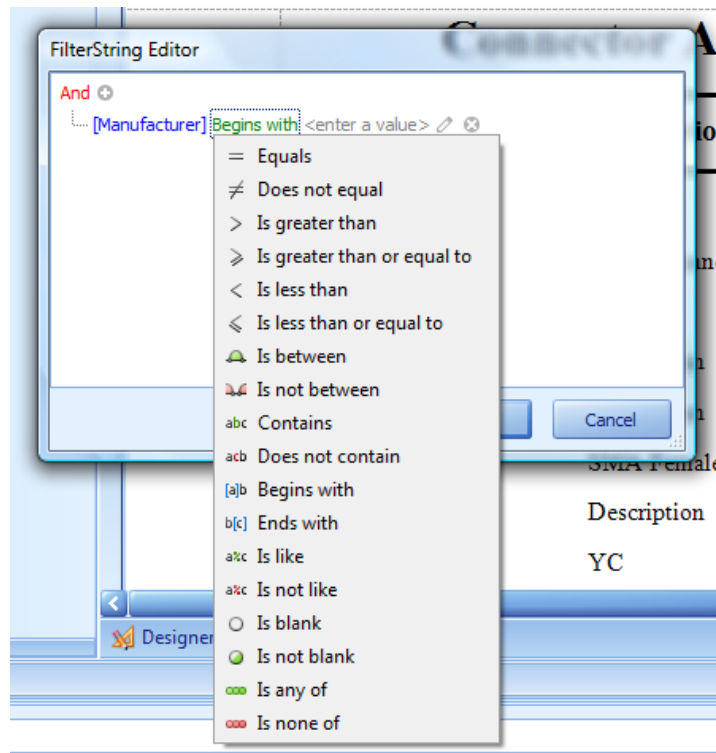

Filters may also contain parameters that the user must enter before the report is generated. In order to make use of this function you must follow these steps:

1. Add a parameter to the report while in Designer view. Click the **Parameters (...)** ellipsis button to view the Parameters collection.
2. Click the [Add] button to add a parameter to the collection.
3. Enter description and default value information.
4. Open the filter editor (see above)
5. Add a condition and edit the comparison, then click on the icon to the right of the field to select parameters.
6. Click **[Preview]** to preview the report. You will see a Parameters pane on the left hand side with a submit button.
7. Enter a value and click **[Submit]**.

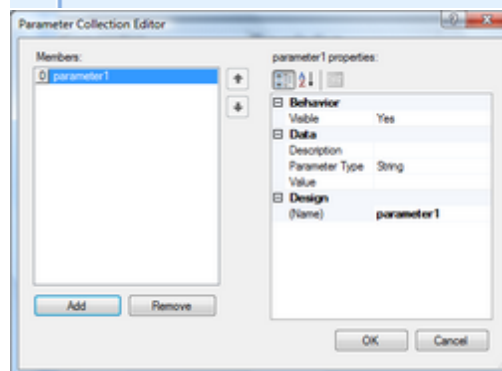
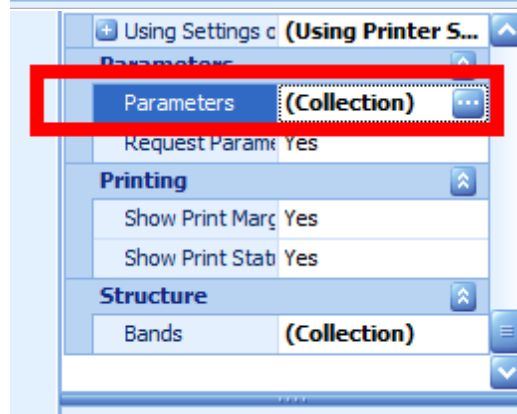

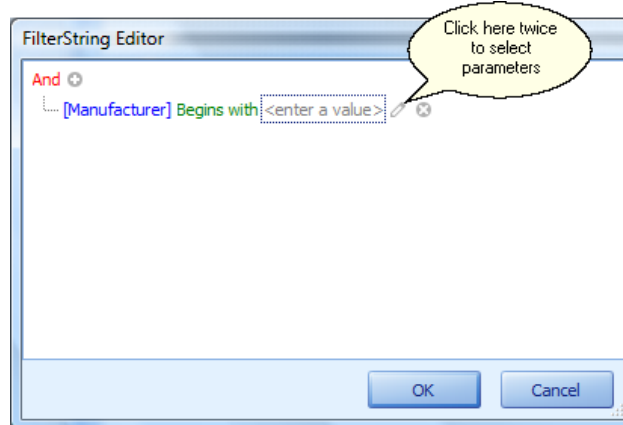
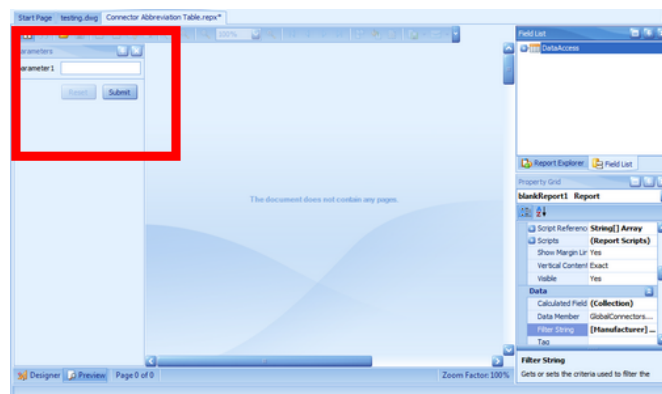
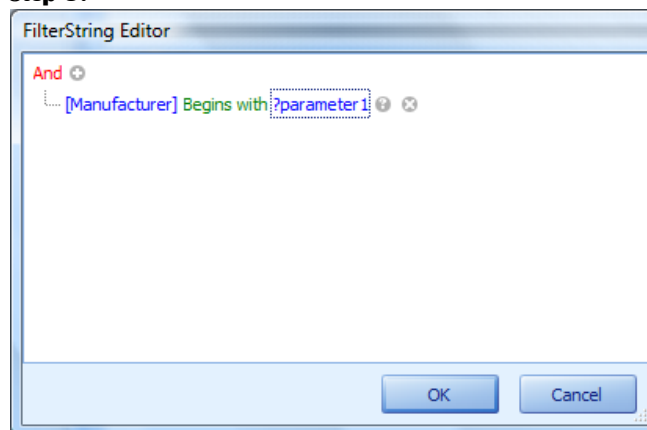
**Step 5.**

4.3 Creating Reports

Contents

[Standard](#) ⁶⁸

[Labels](#) ⁷²

[Report Design Basics](#) ⁷⁶

4.3.1 Standard

Menu: **Report>New Report with Wizard**

Applies To:
XLT PRO
Related Settings:
None

Default command line shortcut: **rw**
 Create a new report

How To: Create a New Report

- Click **Reports>New Report with Wizard**. Alternately: from the Project Explorer - click **New Report with Wizard**

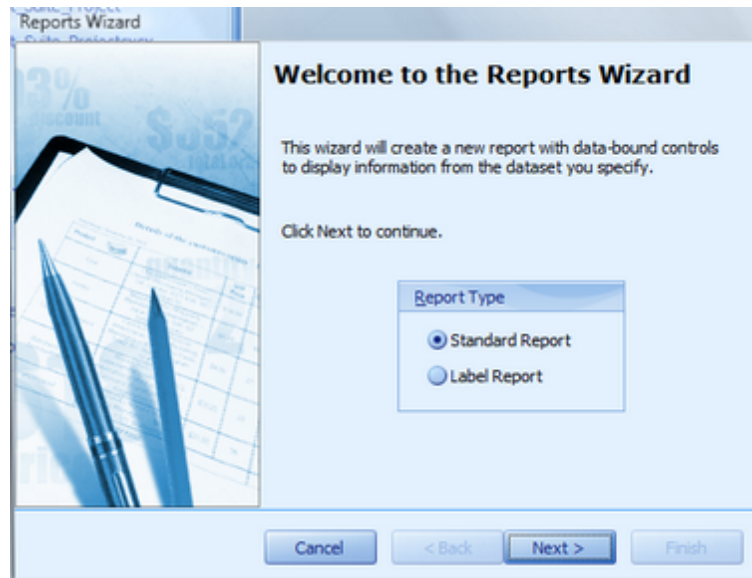

- Select the **Standard Report** option. Click **[Next >]**
- Select a data collection. Data collections access both the global and project databases. For example: say you wanted to show a list of all manufacturers. You would select the **GlobalManufacturersCollection**.

Note: collections are hierarchical to aid in the creation of subreports. All collections are populated with data when the report is previewed.

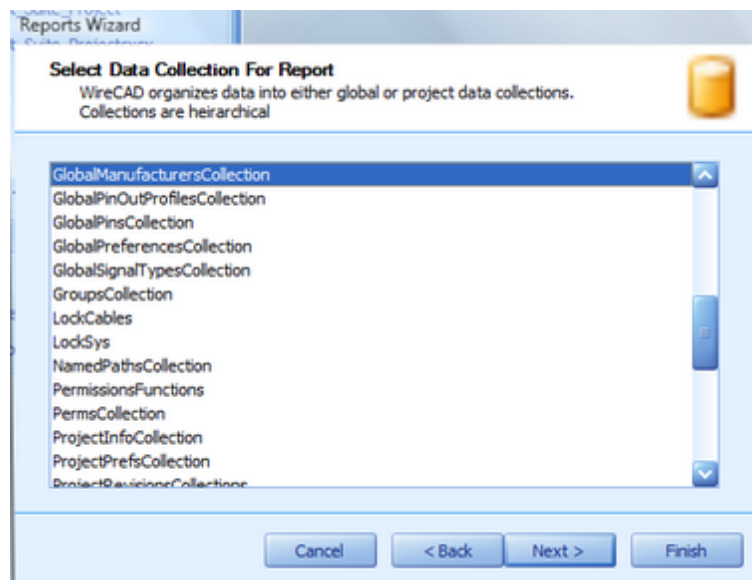

- Select the fields (columns) you wish to display in the report.

Note: use the >>> <<< buttons in the center of the two lists to move items between the lists

The screenshot shows the 'Reports Wizard' dialog box at the 'Choose columns to display in your report' step. The title bar reads 'Reports Wizard' and 'Columns: ReportColumns'. The main heading is 'Choose columns to display in your report' with a subtitle 'Your report can display any of the columns available in the dataset.' Below this, the question 'Which columns do you want to display in your report?' is posed. There are two lists of available fields. The left list, titled 'Available fields:', contains: ManuGUID, ManufacturerID, DisplayInEquipment, DisplayInCableTypes, User Added, ModifiedBy, ModifiedOn, and CreatedOn. The right list contains: ManufacturerName, ManufacturerWebSite, and ManufacturerImage. Between the lists are four arrow buttons: >, >>, <, and <<. At the bottom are buttons for 'Cancel', '< Back', 'Next >', and 'Finish'.

- Apply any grouping

The screenshot shows the 'Reports Wizard' dialog box at the 'Do you want to add any grouping levels?' step. The title bar reads 'Reports Wizard' and 'Columns: ReportColumns'. The main heading is 'Do you want to add any grouping levels?' with a subtitle 'Grouping splits data into groups based on identical fields values. You can specify several grouping fields at the same level to perform multiple grouping.' Below this, there are two lists. The left list contains: ManufacturerName, ManufacturerWebSite, and ManufacturerImage. Between the lists are five arrow buttons: >, +>, <, ^, and v. Below the ^ button is the label 'Priority'. To the right of the lists is a preview window showing the text 'ManufacturerName, ManufacturerWebSite, ManufacturerImage'. At the bottom are buttons for 'Cancel', '< Back', 'Next >', and 'Finish'.

- Select a **Layout** and **Orientation** for your report.

Note: the **Adjust field width to fit** function will force all selected fields on to a single page possibly rendering some of the data unreadable. If you have lots of fields to display, consider using a **Justified** report

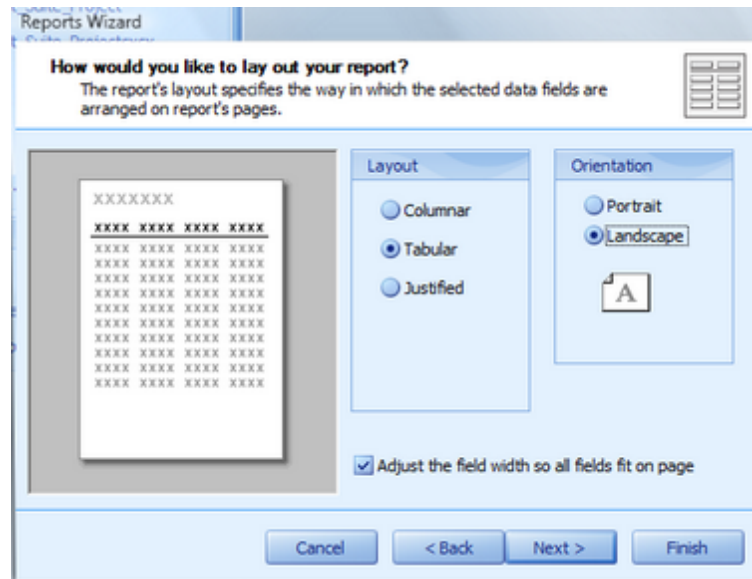

- Select a Report Style

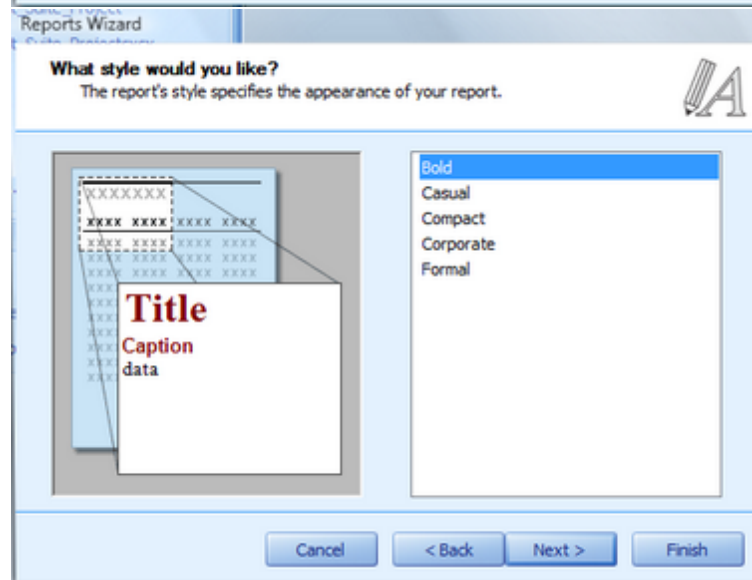

- Title your report

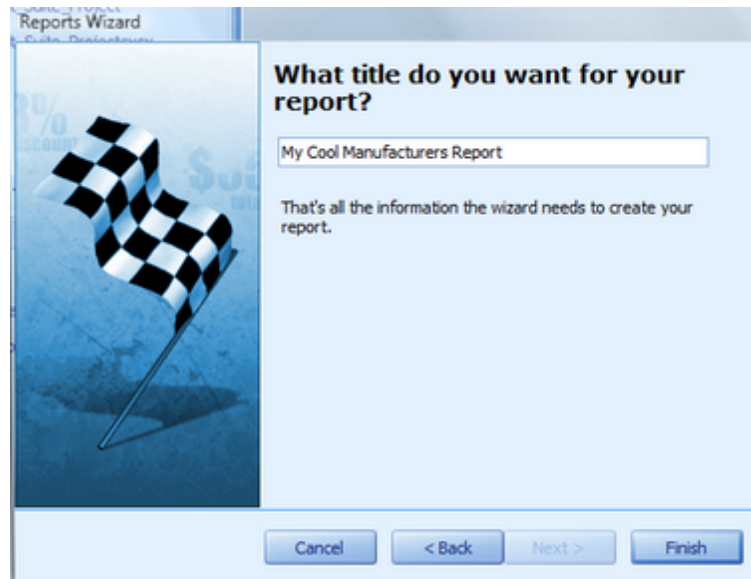

- Click **[Finish]** to create your shiny new report.

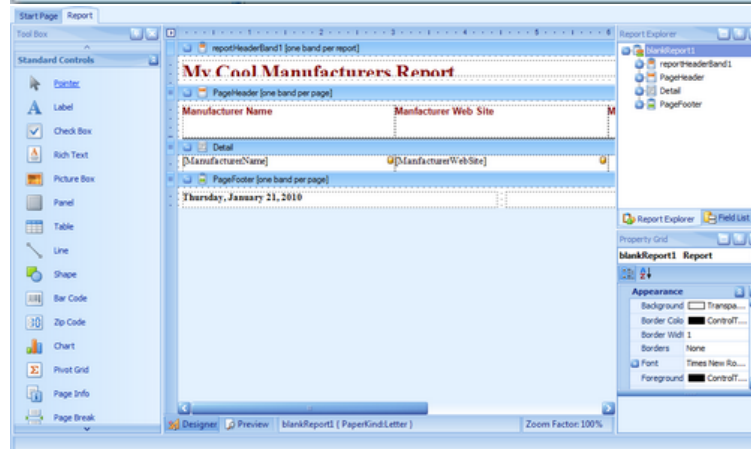

- Click **File>Save** and save your work to your reports support path

4.3.2 Labels

Menu: **Report>New Report with Wizard**

Default command line shortcut: **rw**
Create a new label report

Applies To:
XLT PRO
Related Settings:
None

How To: Create a New Label Report

- Click **Reports>New Report with Wizard**. Alternately: from the Project Explorer - click **New Report with Wizard**



- Select the **Label Report** option. Click [**Next >**]
- Select a data collection. Data collections access both the global and project databases.

Note: In the case of labels we probably want to use the **CablesCollection**

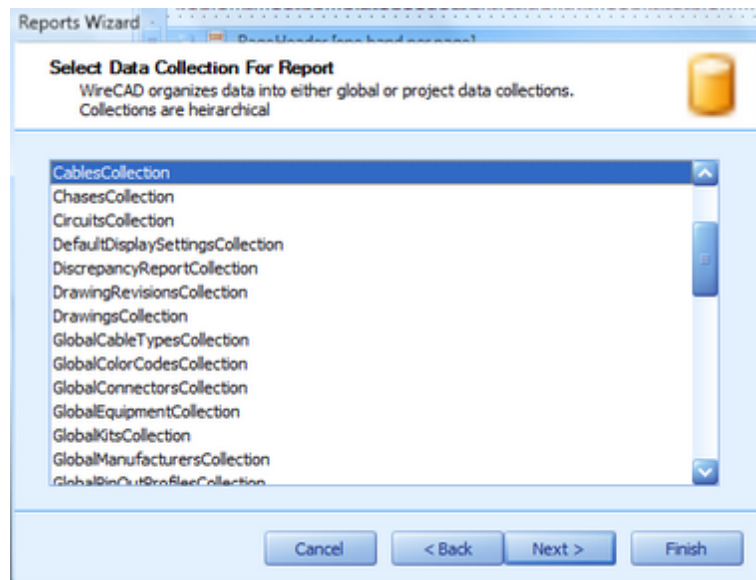

- Select a label format. WireCAD comes stock with over 1000 label formats from 15 manufacturers including Panduit, Hellerman Tyton and Brady.

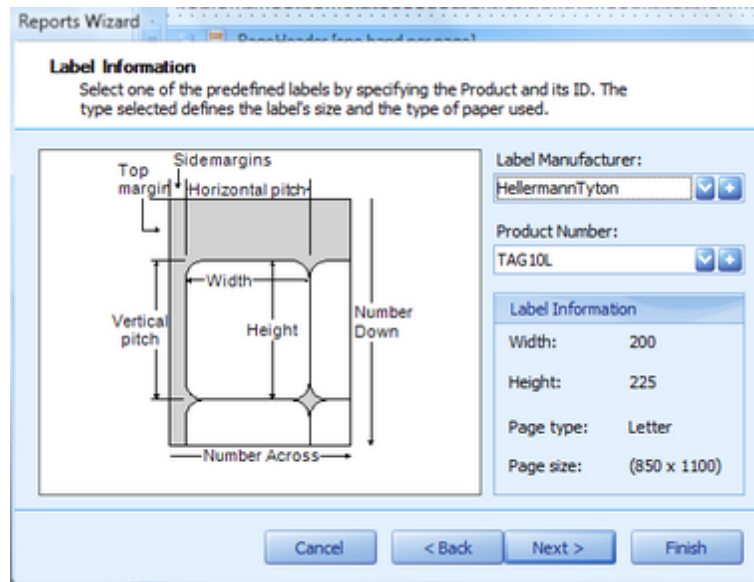

- Modify and of the nudge factors and select the sheet size

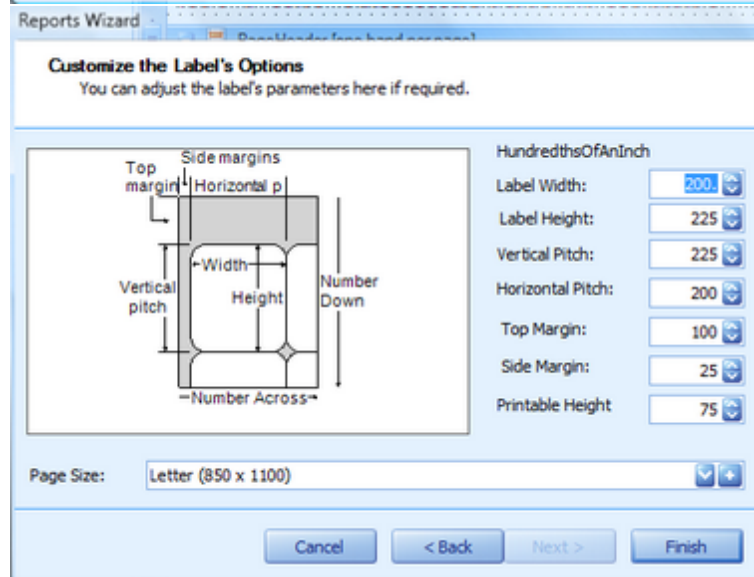

- Click **[Finish]** to create your shiny new report.

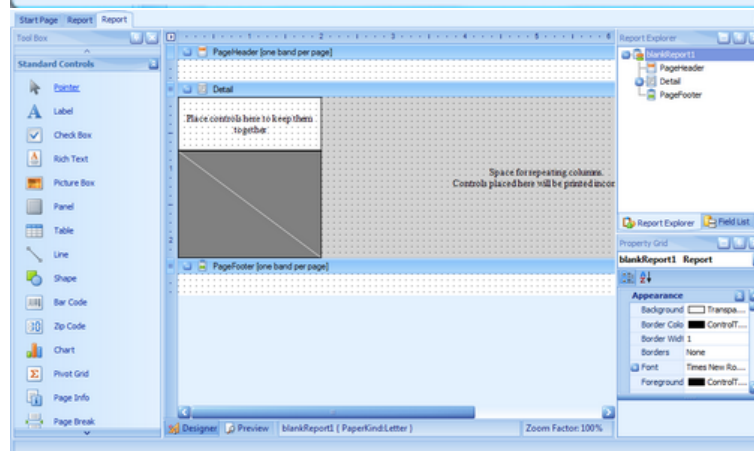

- Select the Field List and drag any fields that you wish to display on to the report design surface.

Note: avoid placing field on the light and dark grey areas. The light grey area will not print and the dark grey is indicative of the clear laminating portion of a cable label.

Report Explorer Field List

PageHeader [one band per page]

Detail

[CableNo]

[SRCSys]>[SRCPin]

[DestSys]>[DestPin]

Space for Controls placed here

PageFooter [one band per page]

DV-1030-	DAT-10030-	DA-1001-	V-1005-
DV3-01>B-05	SRVE-105>KB	SRVE-01>AES 1,2	DV3-01>B
DV3-02>A-05	SERVER-01>CH2-422	SRVE-01>VIDEO	DV3-02>A
D-1002-	V-10066-	V-10045-	DV-1001-
SRVE-101>ENET	SERVER-01>COMP1	DV3-01>B-12	SRVE-01-
SRVE-10>GENLOCK	DV3-01>A-11	DV3-02>A-12	SRVE-02-

- Final output looks like this

- Click **File>Save** and save your work to your reports support path

4.3.3 Report Design Basics

The following topic assumes that you have either opened a new blank report or that you have run the New Report Wizard.

Navigating the Designer

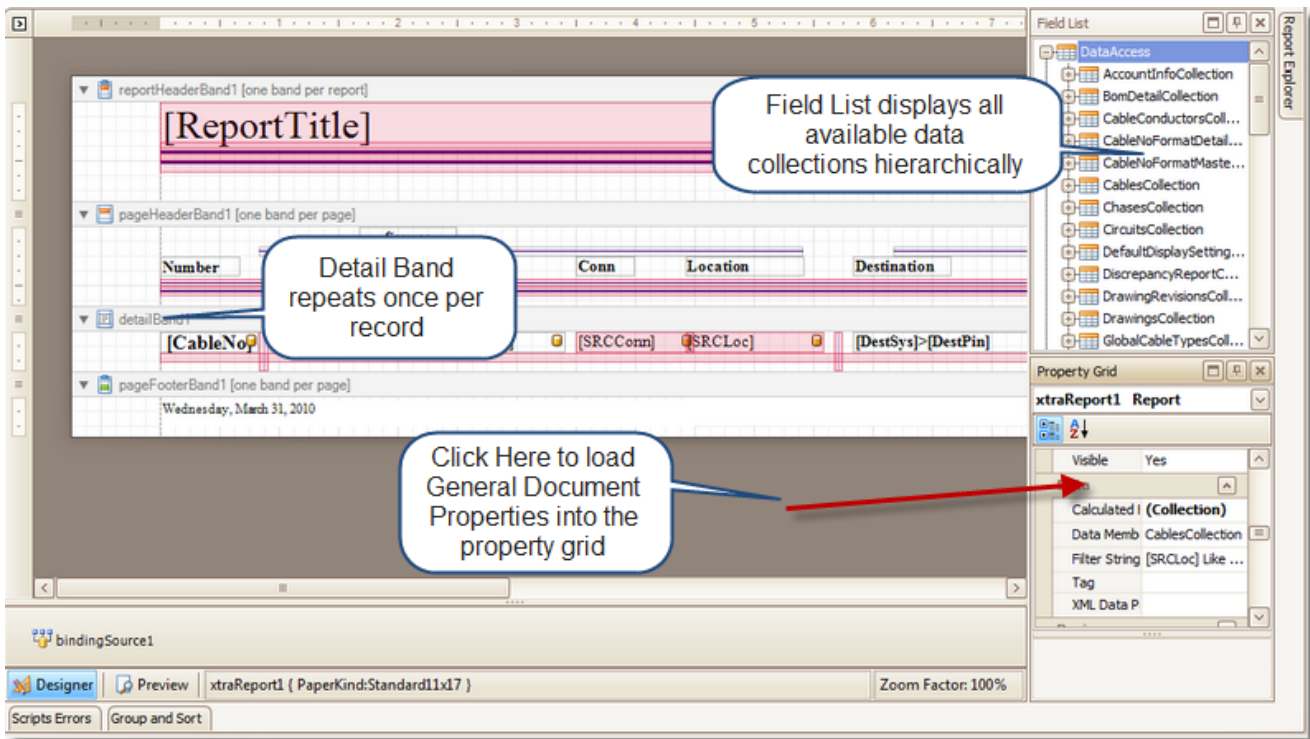
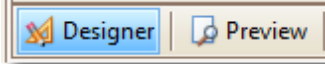

If you open a new report without running the wizard you will need to set the report Data Member variable. Click in the dark grey area to load the general properties. Select the Data Member from the drop down.

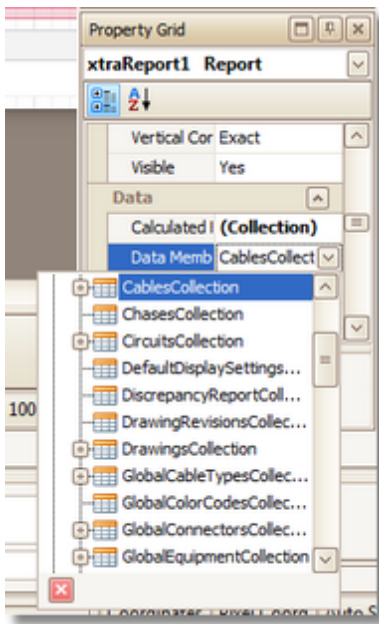

You can drag fields from the Field List directly to the report designer.

If you want to concatenate multiple fields in a single label you can drag multiple fields onto the same label or edit it directly.

To edit a label double-click it to enter edit mode.



Type directly into the label. Field names must be enclosed in [] brackets.

Part



5 Advanced Topics

Contents

[SysName Formatting](#) ^[79]

[Cable Number Formatting](#) ^[81]

5.1 SysName Formatting

Menu: **Project Explorer>Project Databases>Project SysName Format**

Default command line shortcut: **fsys**

XL FREE does not support changing the format

Allows control of the SysName numbering scheme. Using the SysName Format dialog you can select any field that is associated with the SysName and concatenate it into your own numbering scheme. Each of the fields selected can be formatted and the numbers can be set to sequence off of another field.

Applies To:

XLT PRO

Related Settings:

None

Topics

[How it Works](#) ^[79]

[Controls Explanation](#) ^[80]

[Available Variables](#) ^[80]

[More About Regex](#) ^[81]

How it Works

The SysName format tool is used to generate regular expressions that are then used to parse SysName info as well as provide formatting information to masked text boxes.

A note on regular expressions: WireCAD v6 makes extensive use of regular expressions (Regex). Regular expressions are a well documented string parsing tool. Much has been written on them. It is not within the scope of this quick start guide to fully explain regular expressions; however, a google search will tell you more than you ever wanted to know.

Two forms of regular expression are generated: a simplified form that is used as a mask in both the Systems database and in textboxes, and a complex form that aids in the generation of queries to determine the next number in a sequence. The following are both the simplified and complex regex for the default format:

```
\w{1,6}-\d{1,5}
```

```
(?<EQUIPMENTTYPE>\w{1,6})-(?<NUMERICSEQUENCE>\d{1,5})
```



NOTE: WireCAD supports multiple formats in the same database. In order to accomplish this we use the simplified Regex as a mask. If you have any data in the Project Systems table and you change ANYTHING in ANY Format field you will change the mask and therefore the sequence. You must decide if the change is such that it warrants copying the new simplified Regex to all records in the Project Systems table in order to keep your sequence.

Controls Explanation

Selected Format

Selected the current SysName format. Allows addition and deletion of formats as well.

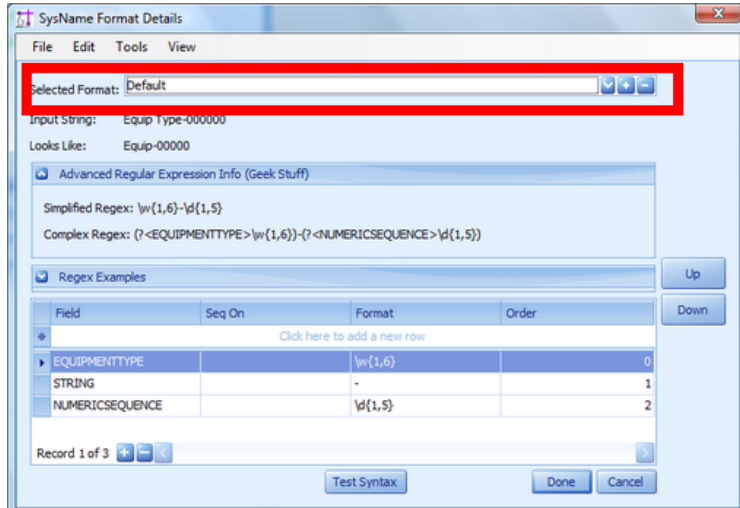

Variable List

Displays the sequence of variables in grid view that will be concatenated into the final SysName.

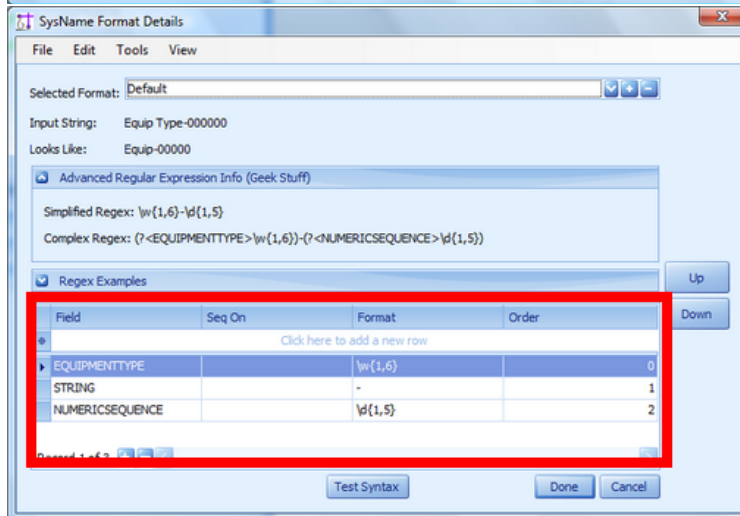

Available Variables

Variable	Description	Sequencable	Default Format (regex)
MANUFACTURER	Manufacturer Name	X	\w{1,6}
EQUIPMENTNAME	Equipment Name/PN/Model Number	X	\w{1,6}
DESCRIPTION	The device description as contained in the global equipment library	X	\w{1,6}
EQUIPMENTTYPE	The Equipment Type as contained in the global equipment library	X	\w{1,6}
LOCATION	The location typed in the SysName edit dialog	X	\w{1,6}
ELEVATION	The location typed in the SysName edit dialog	X	\w{1,6}

STRING	any string (usually used for delimiters like dashes (-))		-
NUMERICSEQUENCE	a numeric sequence that starts with the project starting number		\d{1,5}
ALPHASEQUENCE	an alpha sequence that starts at the letter 'a'		\w{4}
USER1	the global equipment library device definition user1 field		\w{1,6}
USER2	"		\w{1,6}
USER3	"		\w{1,6}
USER4	"		\w{1,6}

SeqOn

This variable should sequence on another variable's value.

Order

The order in the list of the variable

More About Regex

The **Format** field uses regular expressions. The following are some simple examples:

\w{1,6}	Any non number, non punctuation string from 1 to 6 characters
\w*	Any non number, non punctuation string any length
[a-zA-Z0-9]{5}	Lower / Upper case and 0 thru 9 exactly 5 characters
\d{1,5}	Digits 1 to 5 digits in length
\d*	Digits any length
\\	a slash "\". The \ is the escape character so you need two
-	a dash except when in [] or {} then a range.
[a-zA-Z0-9_-\,]{1,4}	Lower / Upper case, 0-9, underscore, dash, and comma.

5.2 Cable Number Formatting

Menu: **Project Explorer>Project Databases>Project Cable Number Format**

Applies To:
XLT PRO
Related Settings:
None

Default command line shortcut: **fcab**

XL FREE does not support changing the format

Allows control of the Cable numbering scheme. Using the Cable Number Format dialog you can select any field that is associated with the Cable Number and concatenate it into your own numbering scheme. Each of the fields selected can be formatted and the numbers can be set to sequence off of another field.

Topics

- [How it Works](#)^[79]
- [Controls Explanation](#)^[80]
- [Available Variables](#)^[83]
- [More About Regex](#)^[81]

How it Works

The Cable Number format tool is used to generate regular expressions that are then used to parse Cable Number info as well as provide formatting information to masked text boxes.

A note on regular expressions: WireCAD v6 makes extensive use of regular expressions (Regex). Regular expressions are a well documented string parsing tool. Much has been written on them. It is not within the scope of this quick start guide to fully explain regular expressions; however, a google search will tell you more than you ever wanted to know.

Two forms of regular expression are generated: a simplified form that is used as a mask in both the Cables database and in textboxes, and a complex form that aids in the generation of queries to determine the next number in a sequence. The following are both the simplified and complex regex for the default cable number format:

```
\w{1,6}-\d{1,5}-\w*
```

```
(?<SIGNALTYPEPREFIX>\w{1,6})-(?<NUMERICSEQUENCE>\d{1,5})-(?<MULTICOREDATA>\w*)
```



NOTE: WireCAD supports multiple formats in the same database. In order to accomplish this we use the simplified Regex as a mask. If you have any data in the Project Cables table and you change ANYTHING in ANY Format field you will change the mask and therefore the sequence. You must decide if the change is such that it warrants copying the new simplified Regex to all records in the Project Cables table in order to keep your sequence.

Controls Explanation

Selected Format

Selected the current Cable Number format.
Allows addition and deletion of formats as well.

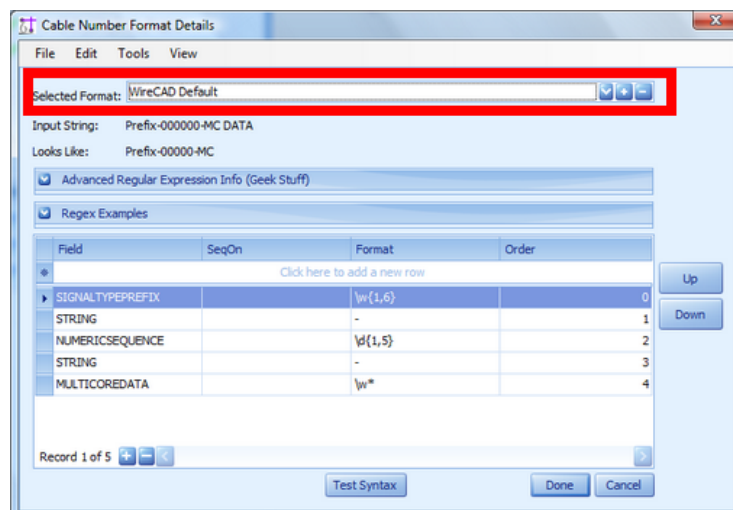

Variable List

Displays the sequence of variables in grid view that will be concatenated into the final Cable Number.

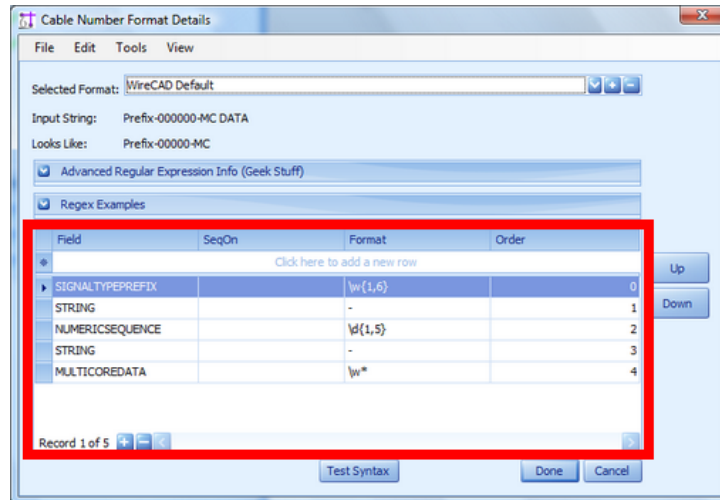

Available Variables

Variable	Description	Sequencable	Default Format (regex)
SIGNALTYPE	The signal type associated with the cable	X	\w{1,4}
SIGNALTYPEPREFIX	the signal type prefix associated with the signal type of the cable	X	\w{1,4}
SOURCESYSTEM	The source SysName	X	\w{1,6}
SOURCEPIN	The source port or pin name	X	\w{1,6}
SOURCEALIAS	The source Alias	X	\w{1,6}
SOURCELOCATION	The source location	X	\w{1,6}
DESTSYSTEM	The destination SysName		\w{1,6}
DESTPIN	The destination port or pin name		\w{1,6}
DESTALIAS	The destination alias		\w{1,6}
DESTLOCATION	The destination alias		\w{1,6}
SOURCE_OR_DEST_PIN_IF_JACKFIELD	Not Yet Implemented		\w{1,6}
MULTICOREDATA	Core data as defined in the associated cable type if any		\w*
STRING	any string (usually used for delimiters like dashes (-))		-
NUMERICSEQUENCE	a numeric sequence that starts with the project starting number		\d{1,5}
ALPHASEQUENCE	an alpha sequence that starts at the letter 'a'		\w{4}
USER1	the global equipment library device definition user1 field		\w{1,6}
USER2	"		\w{1,6}
USER3	"		\w{1,6}
USER4	"		\w{1,6}

SeqOn

This variable should sequence on another variable's value.

Order

The order in the list of the variable

Test Sequence

Performs a basic syntax test on the regular expressions

More About Regex

The **Format** field uses regular expressions. The following are some simple examples:

<code>\w{1,6}</code>	Any non number, non punctuation string from 1 to 6 characters
<code>\w*</code>	Any non number, non punctuation string any length
<code>[a-zA-Z0-9]{5}</code>	Lower / Upper case and 0 thru 9 exactly 5 characters
<code>\d{1,5}</code>	Digits 1 to 5 digits in length
<code>\d*</code>	Digits any length
<code>\\</code>	a slash "\". The \ is the escape character so you need two
<code>-</code>	a dash except when in [] or {} then a range.
<code>[a-zA-Z0-9_-\,\,]{1,4}</code>	Lower / Upper case, 0-9, underscore, dash, and comma.

Part

VI

6 Frequently Asked Questions

Contents

[Placing Custom Titleblocks \(Page Borders\)](#)^[86]
[Creating Custom Titleblocks](#)^[87]
[Moving Projects](#)^[88]
[Synchronizing with Another Equipment Library](#)^[91]
[Setting Up on a Network](#)^[93]
[Upgrading from v5](#)^[93]
[***](#)^[98]

6.1 Placing Custom Titleblocks (Page Borders)

Menu: **Basic CAD Tools>Blocks>Insert Block Into Drawing**
 Default command line shortcut:

Applies To:
 All Product Levels
 Related Settings:
 None

How to Place Custom Titleblocks into Your Drawing

Switch to the Layout in which you intend to place your custom page border
 Open the Insert block into Drawing dialog.

**Basic CAD
 Tools>Blocks>Insert
 Block into Drawing**

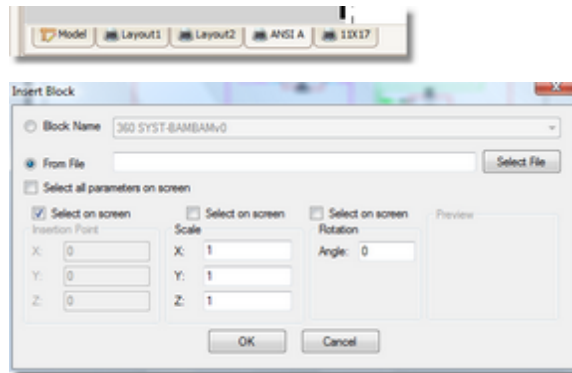

Select **[From File]**
 Browse to the dwg that contains your custom title block in the Model Space
 Click **[OK]** to place the insert into the drawing.

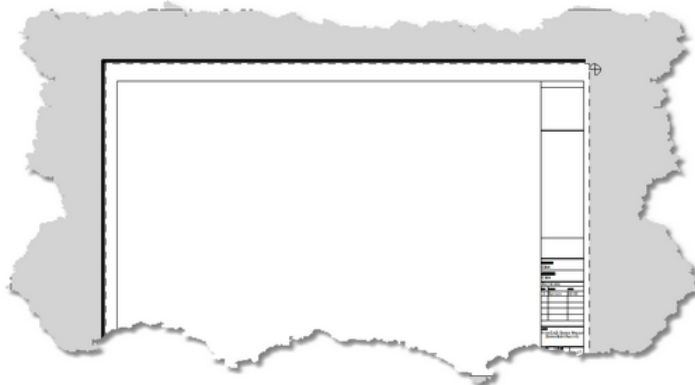

Now you will need to place a Viewport to the model space

Click **View>New Viewport** and select the logical boundaries of the viewport within the titleblock you placed earlier.



Now double-click the viewport to activate it for zooming and panning and use the mouse wheel or zoom commands to position the viewport over the model space.

6.2 Creating Custom Titleblocks

Menu: **Basic CAD Tools>Blocks>Insert Block Into Drawing**
 Default command line shortcut:

Applies To:
 All Product Levels
 Related Settings:
 None

How To: Create Your Own Custom Titleblocks

1. Create a new drawing with no template.
2. Draw your titleblock in Model space scaling it 1:1 with your printed page size, ie an 11x17 page border would be 11x17 minus your margins.
3. Place any images and attribute definitions.
4. Save the drawing.
5. Follow the steps [here](#) ^[86] for placing your title block drawing in any other drawing.

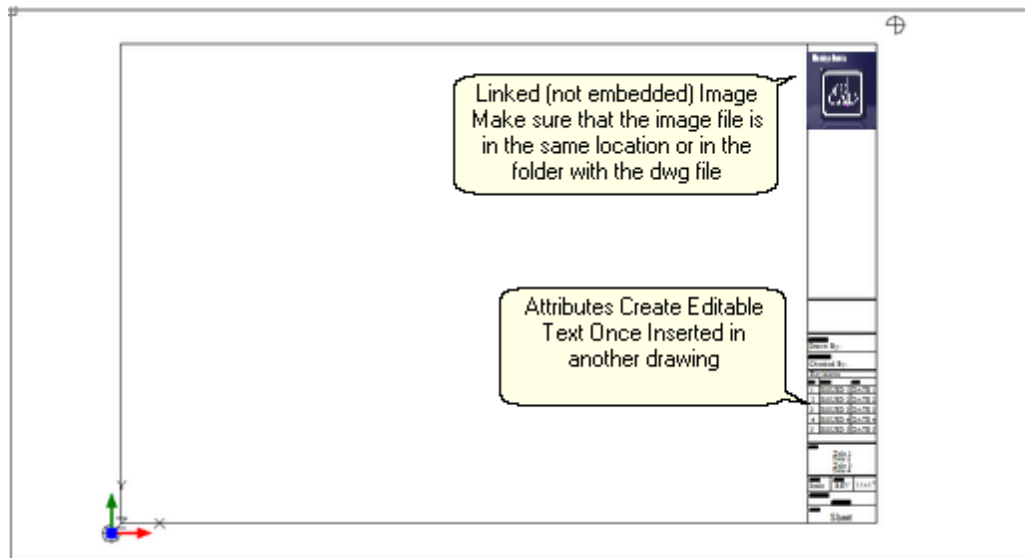

6.3 Moving Projects (Pack Up/Check-Out)

Menu: **Project>Project Utilities>Packup / Check-out**

Menu: **Project>Project Utilities>Unpack**

Menu: **Project>Project Utilities>Check In**

Default command line shortcut:

XL FREE does not support this function

Applies To:
XLT PRO
Related Settings:
None

The Basics

When moving projects from machine to machine there are external items upon which the project depends. These are referred to as project and drawing dependencies. The main project dependency is the global equipment database. Drawings may have image, XRef, and font dependencies. When we Pack Up a project we are grabbing all of those dependencies (fonts are an exception and are not included) and placing them in the Project folder. We may choose to Check Out the project at the same time (PRO only). This flags the project rendering read only until such time as the project is checked back in. Once packed up and/or zipped up you are ready to move the project to another machine. Simply copy the Project folder or the zipped file and move it to the new machine.

Please note that it is beyond the scope of this manual to tell you how to copy and move files in your operating system.

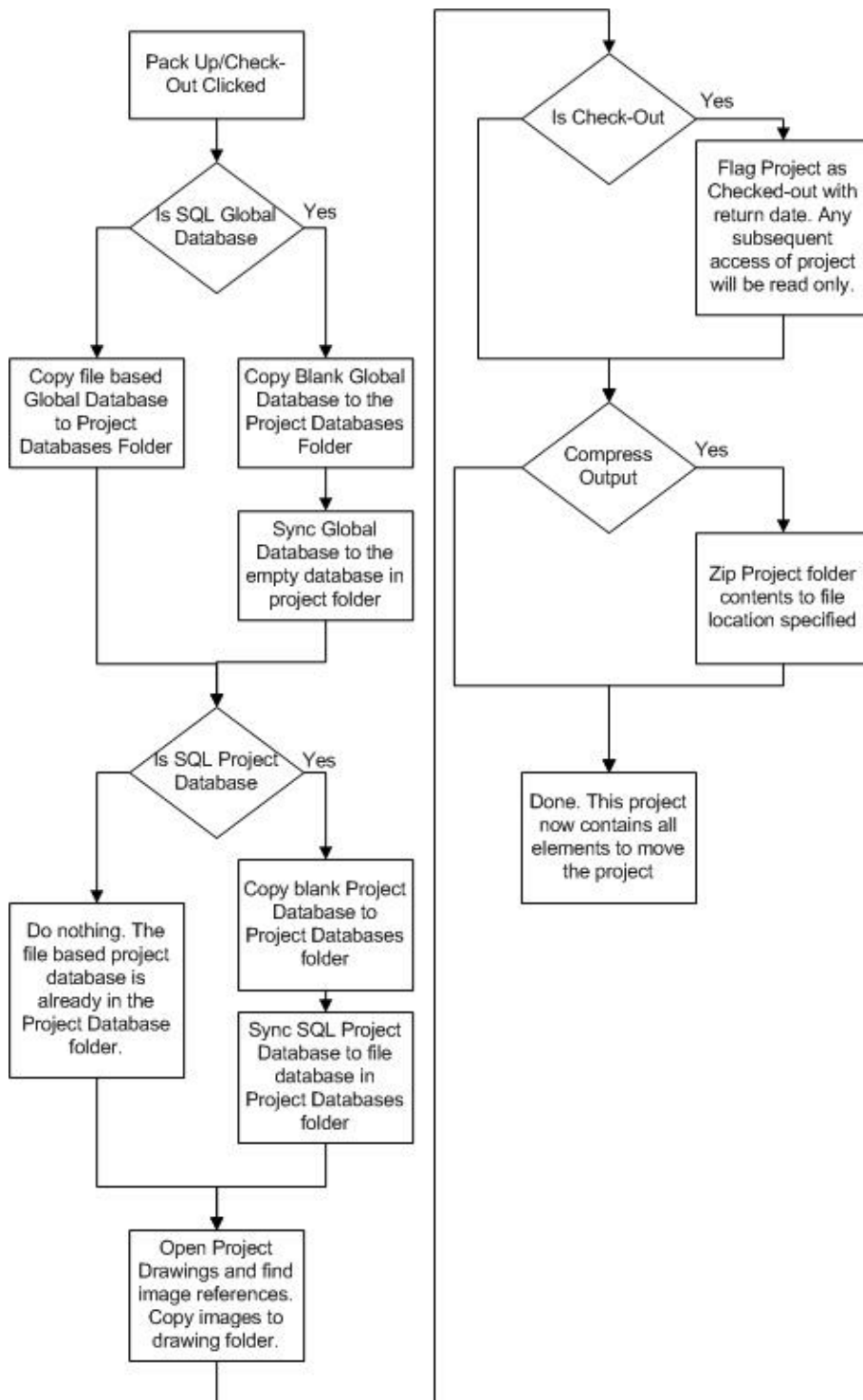

To Unpack or Check In - That is the Question

The two functions are practically identical with the exception that the Check In function won't launch without an active project and once unpacked will mark the active project as Checked In.

Whether you Unpack or Check In a project depends on whether you are moving a project to a machine on which that project already resides and whether you have Checked Out the Project.

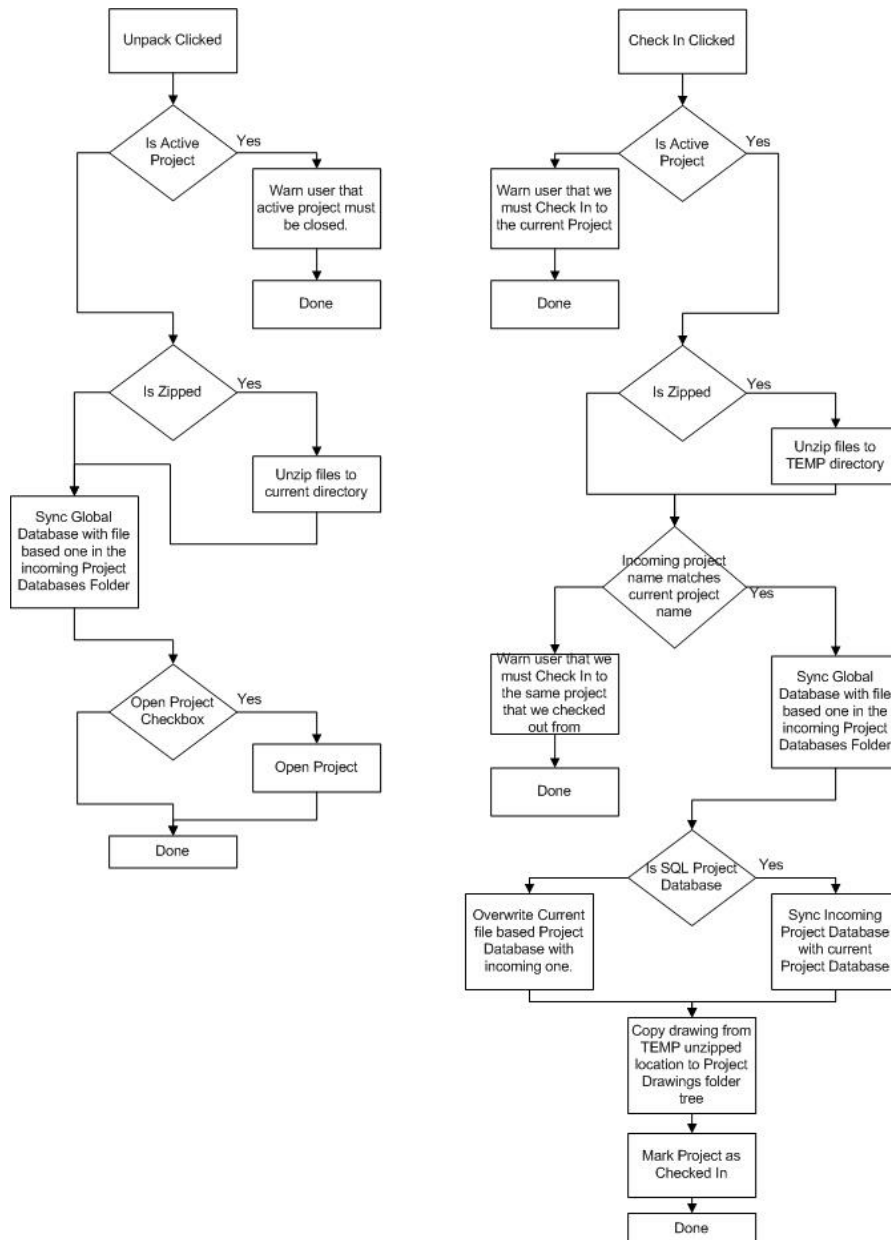

If you have not Checked Out the project then there is no need to Check In the project.

If you are moving a project to another machine, use the Unpack function.

6.4 Synchronizing with Another Equipment Database

Menu: **Database>Sync Equipment Libraries...**

Default command line shortcut:

XL FREE does not support synchronizing another Equipment Database.

Applies To:

XLT PRO

Related Settings:

Syncs the incoming global equipment database to the connected Global Equipment Database

Occasionally you may experience the need to sync with another user's global database. This will copy all of their equipment to your global Equipment Database. The sync includes manufacturers, equipment, inputs, outputs, signal types, connectors, cable types, cable core data, relational tables, etc.

You may choose within the tool to perform an **import, export** or **bidirectional** sync.

Demystifying Synchronization

Synchronizing data in two tables of the same structure is really very simple. In its most basic form, records that do not exist in one table are added. Records that exist in both tables receive the most current data based on a timestamp. In order that records deleted from one table do not get added back in, a special table is employed to track deleted keys. If the delete is the most current action then the record will likewise be deleted from the other table. In the unlikely event that the records have the exact same timestamp, yet the data is different, those records are flagged as conflict records from which you must pick the most correct.

Controls

Database Location

Select either a VistaDB file based database or a SQL Server host. If server based you will need to provide host and credentials. If you do not know them contact your SQL Server database administrator.

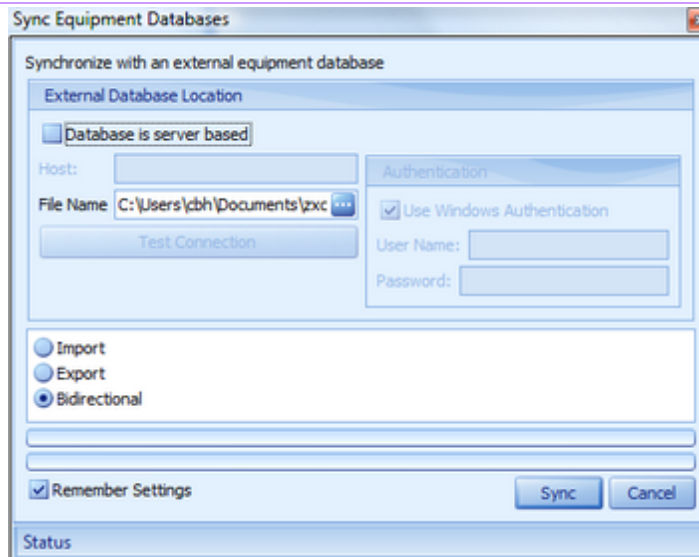

Import, Export, Bidirectional

Self explanatory

Remember Settings Sync

Remember database location information

Initiates the synchronization with the top progress bar showing the overall progress and the bottom showing detail progress.

Status Bar

Displays status of the sync.

At the conclusion of the sync you will be presented with a report that details the records updated here and there.

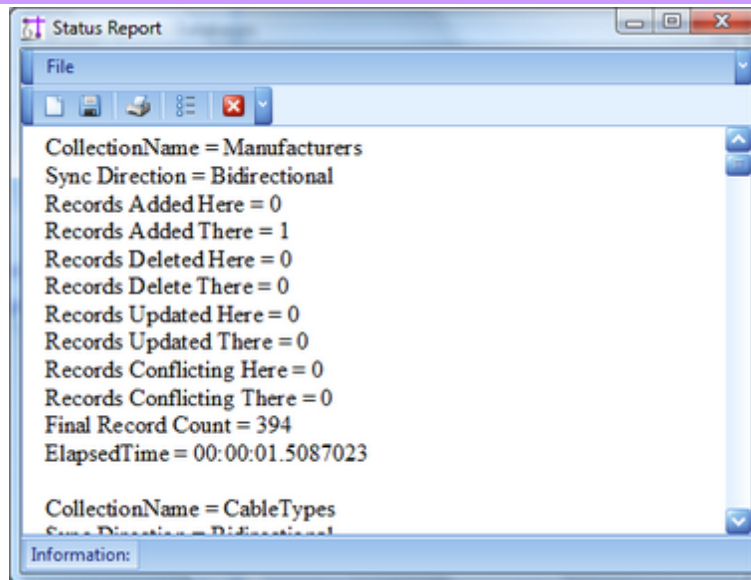

6.5 Setting Up On a Network

What follows is a discussion of several different network topologies and work flows that WireCAD can employ. Regardless of topology or work flow the following steps should be taken for each WireCAD machine. For purposes of this discussion we will distinguish between and Windows user operating under group policy and WireCAD user. The Windows user will be referred to as a OS user. WireCAD users will be referred to as WC users.

1. Install WireCAD
2. Create a network share that is visible to all WireCAD users. Group policy for the OS user of WireCAD should allow the user to read and write the registry (restriction of the registry editor is acceptable), as well as, read and write files on the selected shares, the WireCAD6 folder on the client machine, the OS user's temp directory, the OS user's All Users documents and settings folder trees.
3. Pick one WireCAD client machine from which to copy the global databases and copy from ...\\WireCAD6\\WireCADGlobalEquipment.vdb3 to \\YourNetworkShare\\FolderForWireCADGlobalDatabases\\WireCADGlobalEquipment.vdb3
4. Launch WireCAD on the client machine.
5. Click **Project>Settings{Support Paths}**
6. Modify the support paths for both the Global Equipment database, any blocks or reports that you wish to share among all users.
7. Click **<Done>** and relaunch WireCAD.

Note: The use of mapped network drives is not recommended. Rather use UNC (\\ShareName\\Path\\) drive paths to specify network shares. This will avoid problems with the same share mapped to different drives.

8. Click **Project>Security>View Permissions**. If you are an administrator or rather if your WireCAD identity is that of Administrator, you will have edit ability on this grid.
9. WireCAD v6 uses your Windows groups. You assign permissions to the group. The current user Identity is set to the group thus determining their access level.

6.6 Upgrading from v5

Menu: Various
Default command line shortcut: none

Applies To:
All product levels
Related Settings:
None

If you are upgrading from v5 you will need to take the following steps:

1. Install WireCAD v6
2. Setup your global databases (file based or SQL Server)
3. Click **Database>Import Old Equipment Library**
4. Click the ellipsis (...) and enter the path to the v5 dbEquip.mdb
5. Click **[Next >]**. The import tool will launch and sync the two databases

Note: this may take some time

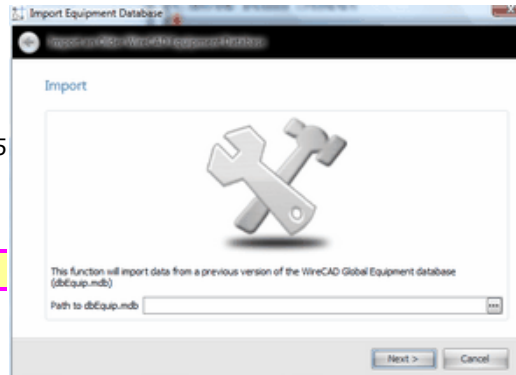

6. Next convert* any projects that you want to work with in v6
7. Click **Project>Convert Old Project**
8. Browse to the old project top folder
9. Select File Based or SQL Server database

If you select SQL Server you will need to enter the host information.

10. Click **[Next >]**
11. Rename if desired
12. Click **[Next >]** to finish

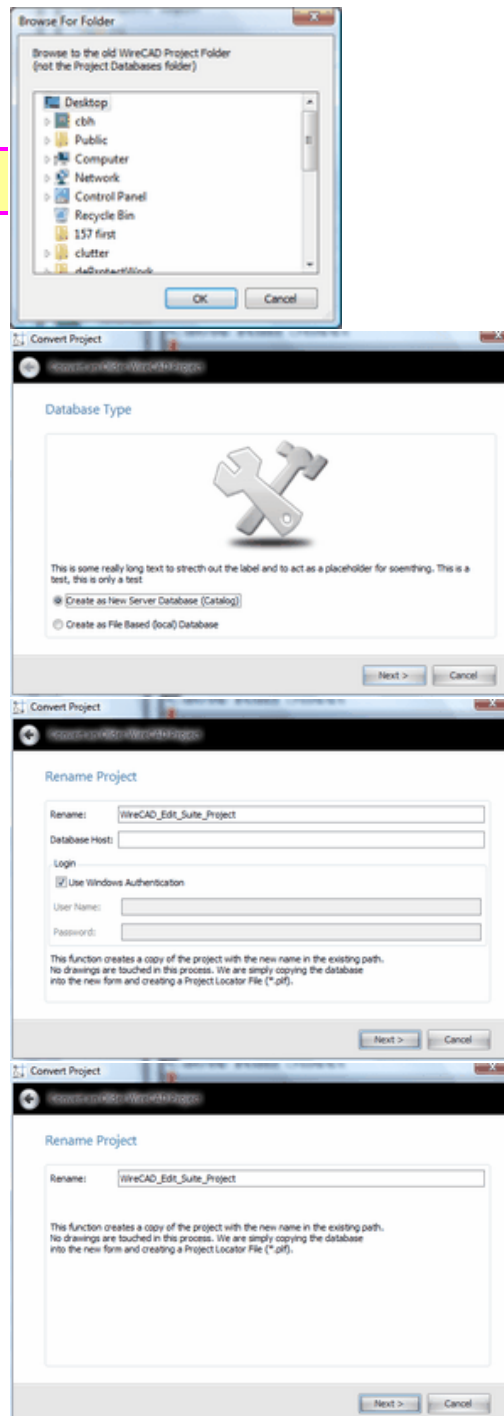

*When WireCAD converts projects no drawings are touched. A new database is created and the old data is imported

Part



7 Choosing a Database Format

Menu: **None**

Default command line shortcut: **none**

Applies To:
PRO
Related Settings:
None

WireCAD v6 PRO allows the use of both file based and server based databases for the project and global databases. The choice of which to use requires some forethought. Listed here are some basic considerations:

	SQL Server	VistaDB (File Based)
Zero Administration		X
Portable		X
ACID Compliant (atomicity, consistency, isolation, durability)	X	X
Database Size	Theoretically unlimited	Theoretical limit is 16 Exabytes (uint64). Practical limit is based upon machine resources. Files are not limited by the database engine, but loading very large databases will require large system resources.
In Process Processing		X

At first glance that the table above it would seem that the proper choice would be the file based solution. However, take note of the last item - In Process Processing means that the WireCAD processes must read and write all data to and from the file based database. Using SQL Server allows us to hand those processes off to the database server creating, in many instances, a significant (read 10X) increase in speed.

Before selecting a database format consider the following questions:

- Will I be moving the project from machine to machine? If yes, consider staying file based on the project.
- Do I have the chops to manage a SQL Server? If no, stay file based. SQL Server requires care and feeding.
- Am I away from my network when I work on WireCAD projects? If you lose connection, WireCAD will become hampered.
- Do I really need the speed enhancements? If you are working on projects with hundreds of thousands of cables, SQL Server is a must.

When you move a project using the **Project>Utilities>Pack Up/Check Out** function and you are using SQL Server databases the database is converted to a file based version and will remain file based from that point forward.

To set up SQL Server see [here](#)^[98]

7.1 SQL Server Setup

It is not within the scope of this manual to provide an in depth discussion of SQL Server. We will touch on the basics required for use with WireCAD.

Basics

The WireCAD distribution includes SQL Server database files for the Global Equipment database. You will need to attach these to the the running server. You will then configure WireCAD to look at the SQL Server for the Global Equipment database. WireCAD projects will create a new database (catalog) for every new project.

You will need to set up permissions for each user to allow them dbcreator privileges. This is the default for localhosts but not remote servers.

There is no further requirement to attach databases once the Global Equipment database.

SQL Server can be set up on a server or on a local machine. WireCAD requires the 2005 version and can use the Express versions which can be found here:

<http://www.microsoft.com/Sqlserver/2005/en/us/express.aspx>

Be sure to download SQL Server Management Studio Express as well. Both are free.

<http://www.microsoft.com/downloads/details.aspx?FamilyID=c243a5ae-4bd1-4e3d-94b8-5a0f62bf7796&DisplayLang=en>

SQL Server does not provide a graphical user interface so you will want to download the management studio listed above.

Setting Up the WireCAD Global Databases on SQL Server

The following assumes that you are installing WireCAD on a local machine. If you are installing on a server you will want to copy the global database files in Step 6 below to the server before you attach them to the server.

1. Install SQL Server. You will be prompted for an instance name. Instance names allow you to have multiple SQL Servers running on the same machine. In addition you will be prompted for a security mode (Windows or SQL), Windows uses your Windows users and groups, SQL ignores these and allows you to manages different users and groups from within SQL Server.
2. Install SQL Server Management Studio (SQLSMS).
3. Launch SQLSMS and log in to the server. If the server is on your local machine you can use the shorthand . \INSTANCENAME for the host.
4. The next step is to attach the global databases.

5. In the Object Explorer right-click the Databases node and click **Attach...**

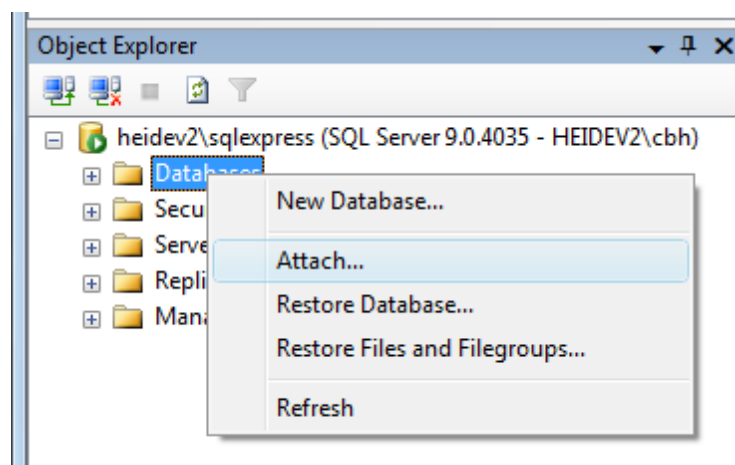

6. Click the **[Add]** button on the Attach Databases form and browse to:

XP:

C:\Documents and Settings\All Users\Shared Docs\WireCAD\WireCAD6\WireCAD_Global_Equipment.MDF

VISTA/7

Public\Public Documents\WireCAD\WireCAD6\WireCAD_Global_Equipment.MDF

The form will look for and add the WireCAD_Global_Equipment_log.LDF file. If it can not find it you will have to add it manually.

7. Click OK to attach the database.

8. You will now need to configure each WireCAD client to look at the SQL Server!

9. Launch WireCAD

10. Click

Project>Application Setup

and follow the steps for

SQL Server.

Part



8 Included Plugins

WireCAD includes a number of plugins that provide additional functionality. WireCAD XL FREE does not load plugins so none of the following information applies to the XL FREE version.

Each plugin will load and register its own command line commands if the plugin provides command functionality.

For information on customizing WireCAD with your own plugins see the [SDK](#) documentation and the SDK samples.

8.1 Pinouts

Menu: **Database>Pinouts**

Default command line shortcut: **po**

Applies To:
PRO
Related Settings:
None

The Pinout utility serves two functions. The first is to generate pinout detail drawings

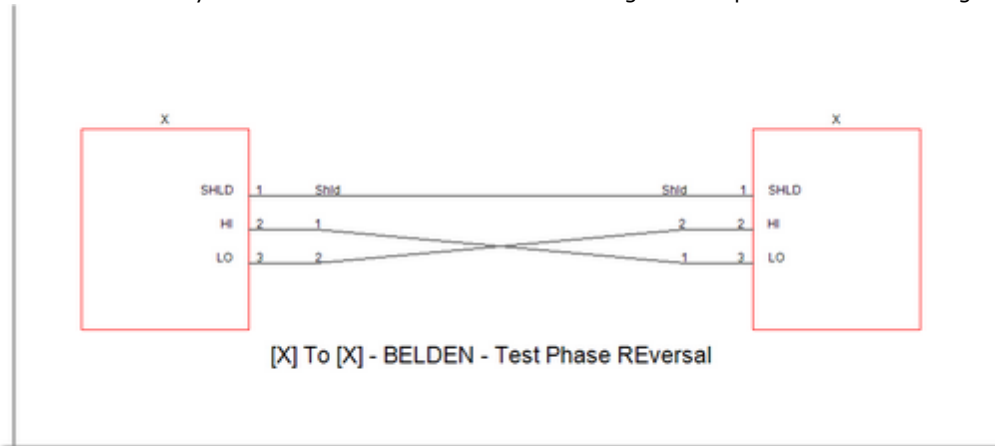

The second is to generate data that can be used in the conductors table under any cable that we wish to attach the data to.

Lefthand Connector			Cable Type		Righthand Connector		
LH Connector	LH Pin	LH Function	Conductor Number		RH Connector	RH Pin	RH Function
LH Jumpered To	LH Termination Method		Gauge	Color Code	RH Jumpered To		RH Termination Method
X	1	SHLD	Shld		X	1	SHLD
			Shld				
X	2	HI	1	01	X	3	LO
X	3	LO	2	02	X	2	HI

8.2 Search

Menu: **None**

Default command line shortcut:

The Search utility provides a search tool window that allows the user to search all of the data collections. For example, if you wanted to find all occurrences of the cable number 1001 the search utility could show you.

NOTE: The search utility only searches the data collections not the drawings.

Applies To:
PRO
Related Settings:
None



8.3 Translation Manager

Menu: **Plugins>Translation Manager**

Default command line shortcut: **none**

The translation utility provides a means by which all strings, captions, and messages may be translated to a different language.

Applies To:
PRO
Related Settings:
None

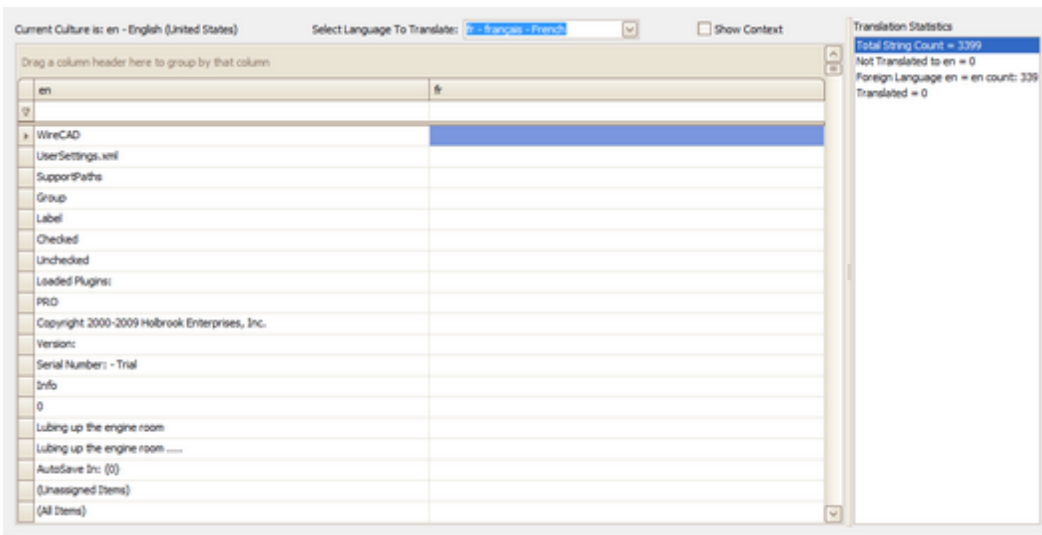

Here we see the Translation manager with the English version on the left and the French version on the right. The pane on the right-hand side shows statistics.

You can right-click a column header and select the KeyString column to should the base English string that the program searches from.

Controls

Current Culture is:	The culture of your machine. If no translation exists, WireCAD defaults to the en (English) language.
Select Language To Translate:	Selects the language to edit in the right-hand column.
Show Context	Select to display a column showing the primary context in which the string or message appears.

8.4 Block Extractor

Menu: **Plugins>Extract All Blocks**

Default command line shortcut: **exall**

Requires an active drawing.

Extracts all blocks in the current drawing to the folder of your choosing. Files are written out of the drawing as individual dwg files with the name of the block. The basepoint of the drawing (origin) is the insertion point of the block.

Applies To:
PRO, XLT
Related Settings:
None

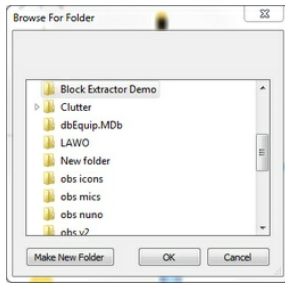
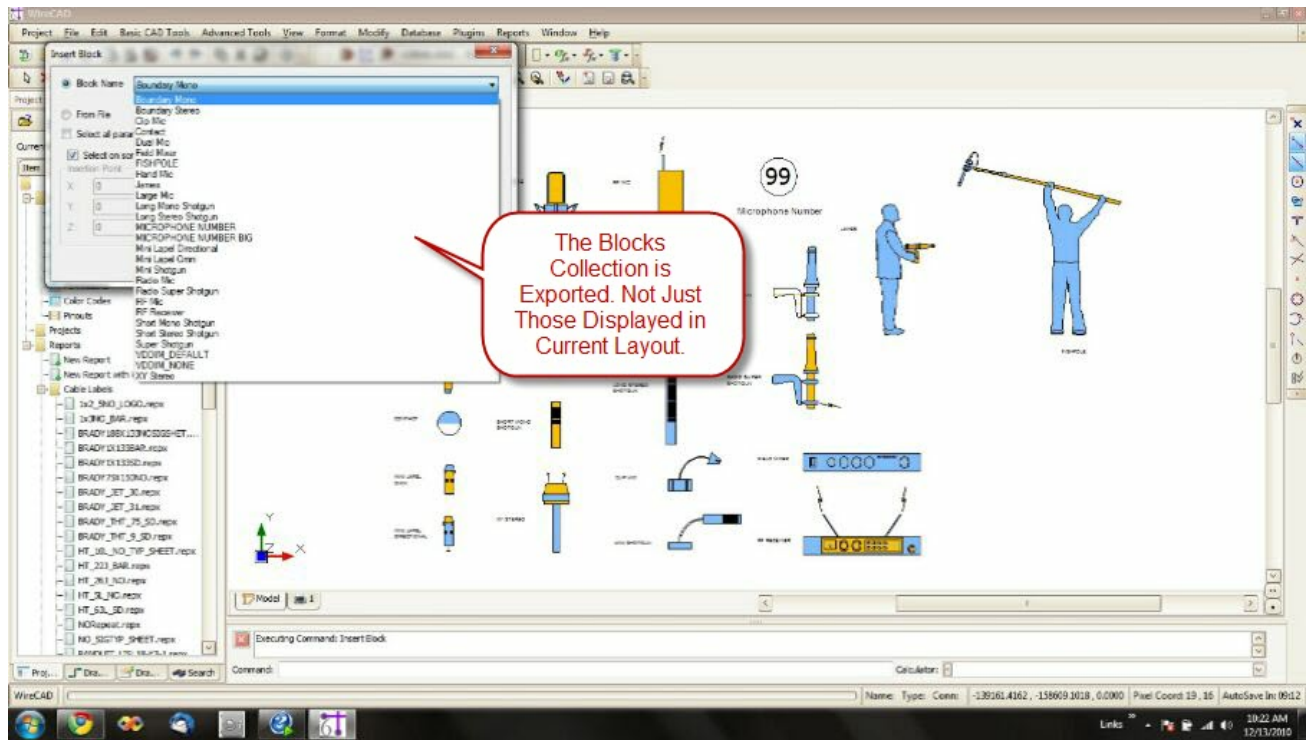

Name	Date modified	Type	Size
Boundary Mono.dwg	12/13/2010 10:32 ...	WireCAD6 DWG D...	61 KB
Boundary Stereo.dwg	12/13/2010 10:32 ...	WireCAD6 DWG D...	62 KB
Clip Mic.dwg	12/13/2010 10:32 ...	WireCAD6 DWG D...	63 KB
Contact.dwg	12/13/2010 10:32 ...	WireCAD6 DWG D...	60 KB
Dual Mic.dwg	12/13/2010 10:32 ...	WireCAD6 DWG D...	63 KB
Field Mixer.dwg	12/13/2010 10:32 ...	WireCAD6 DWG D...	81 KB
FISHPOLE.dwg	12/13/2010 10:32 ...	WireCAD6 DWG D...	70 KB
Hand Mic.dwg	12/13/2010 10:32 ...	WireCAD6 DWG D...	65 KB
James.dwg	12/13/2010 10:32 ...	WireCAD6 DWG D...	83 KB
Large Mic.dwg	12/13/2010 10:32 ...	WireCAD6 DWG D...	67 KB
Long Mono Shotgun.dwg	12/13/2010 10:32 ...	WireCAD6 DWG D...	65 KB
Long Stereo Shotgun.dwg	12/13/2010 10:32 ...	WireCAD6 DWG D...	66 KB
MICROPHONE NUMBER BIG.dwg	12/13/2010 10:32 ...	WireCAD6 DWG D...	60 KB
MICROPHONE NUMBER.dwg	12/13/2010 10:32 ...	WireCAD6 DWG D...	60 KB
Mini Lapel Directional.dwg	12/13/2010 10:32 ...	WireCAD6 DWG D...	63 KB
Mini Lapel Omni.dwg	12/13/2010 10:32 ...	WireCAD6 DWG D...	62 KB
Mini Shotgun.dwg	12/13/2010 10:32 ...	WireCAD6 DWG D...	64 KB
Radio Mic.dwg	12/13/2010 10:32 ...	WireCAD6 DWG D...	61 KB
Radio Super Shotgun.dwg	12/13/2010 10:32 ...	WireCAD6 DWG D...	83 KB
RF Mic.dwg	12/13/2010 10:32 ...	WireCAD6 DWG D...	61 KB
RF Receiver.dwg	12/13/2010 10:32 ...	WireCAD6 DWG D...	90 KB
Short Mono Shotgun.dwg	12/13/2010 10:32 ...	WireCAD6 DWG D...	62 KB
Short Stereo Shotgun.dwg	12/13/2010 10:32 ...	WireCAD6 DWG D...	62 KB
Super Shotgun.dwg	12/13/2010 10:32 ...	WireCAD6 DWG D...	74 KB
VDDIM_DEFAULT.dwg	12/13/2010 10:32 ...	WireCAD6 DWG D...	60 KB

8.5 Bulk Block Fixer

Menu: **Plugins>Bulk Block Fixer**

Default command line shortcut: **blkf**

The Bulk Block Fixer utility provides a means by which dwg files may be easily converted for use with WireCAD. The fixer will convert a single drawing or all drawings in a folder.

Applies To:
PRO, XLT
Related Settings:
None

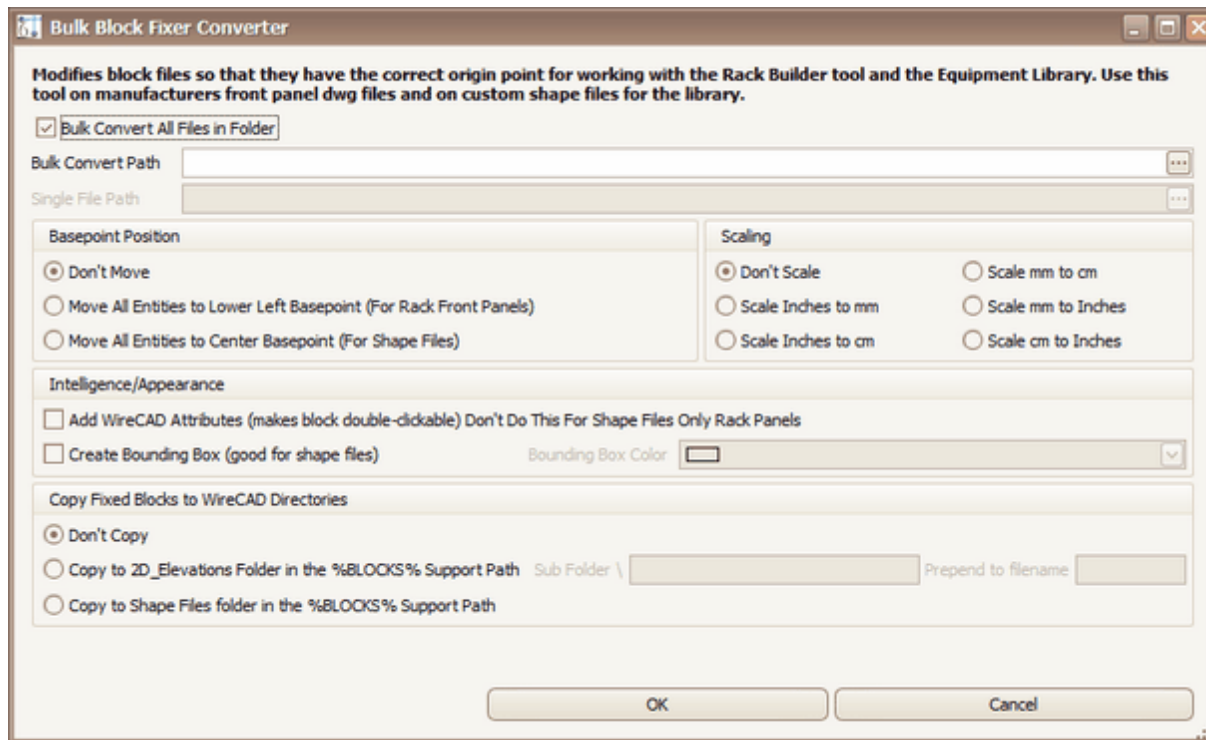

Bulk Block Fixer Dialog

Bulk Convert All Files In Folder

Checked performs selected options on all files in selected folder

Basepoint Position

Don't Move - Do nothing.

Move All Entities To Lower Left Basepoint.

Before:

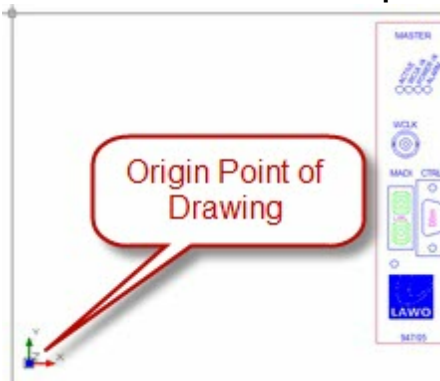

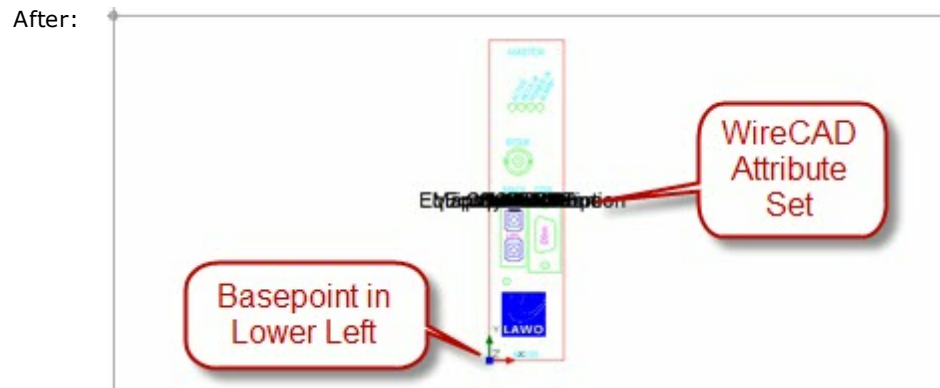

Move All Entities To Center Basepoint.

Before:

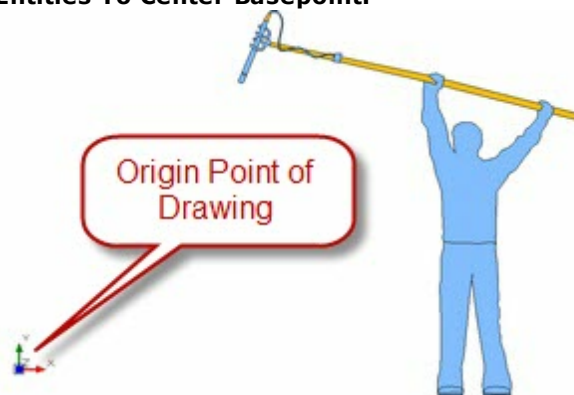

After:



Scaling Intelligence/ Appearance

Scales all drawing objects based on the selection.

Add WireCAD Attributes. - Use this function to add the standard WireCAD attribute set to the dwg file. This makes inserted items double-clickable. This is not required, and should not be used, if you are using the dwg file as a DWGIcon or Custom Shape file.

Create Bounding Box - Creates a rectangle around the entities in the dwg file of the color selected. This is useful for DWGIcons or Custom Shape files

Copy

Copies fixed block files to the selected directories.

\Subfolder and Prepend allow you to modify the location and filename upon copy.

8.6 DWG Diff

8.6.1 Introduction

Welcome to the DWG Diff Help File

DWG Diff is a utility that displays the differences (and commonalities) between two dwg drawings.

Features:

- Open, View, Print dwg files.
- Difference the selected layout.
- Display Common, A not B, B not A drawing elements.
- Displays not only the drawing entity differences but also lists difference in the drawing structure such as:
 - Layers
 - Layouts
 - Text Styles
 - Blocks
 - Dimension Styles
- Save the differenced drawings as dwg or pdf.
- Print the differenced drawings.
- Control the layers.

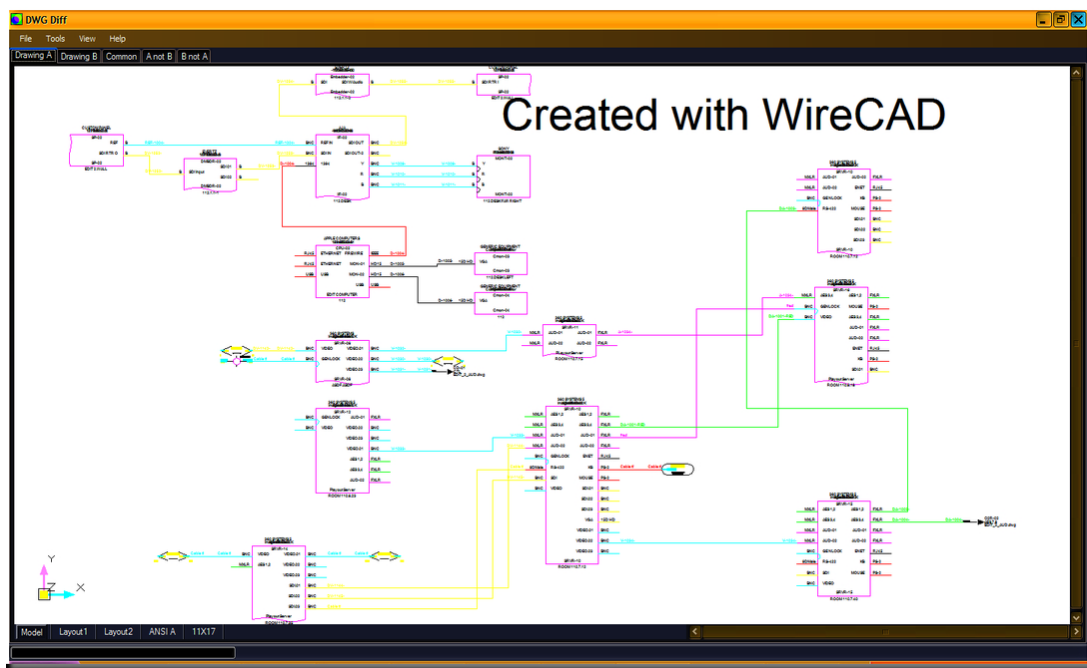

8.6.1.1 Screen Shots

Drawing A

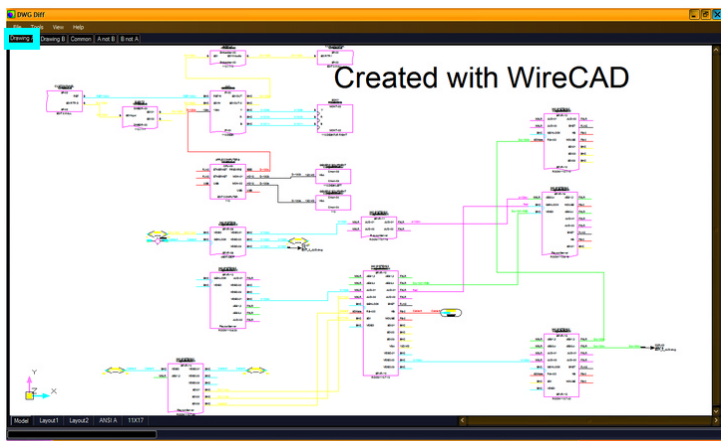

Drawing B

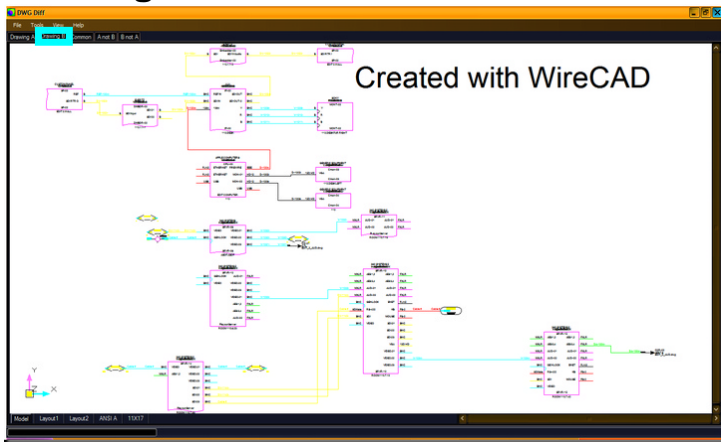

Common to Both

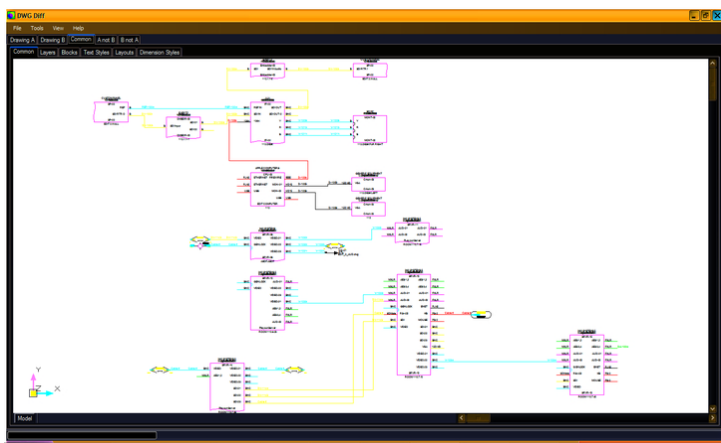

Entities in A but not B

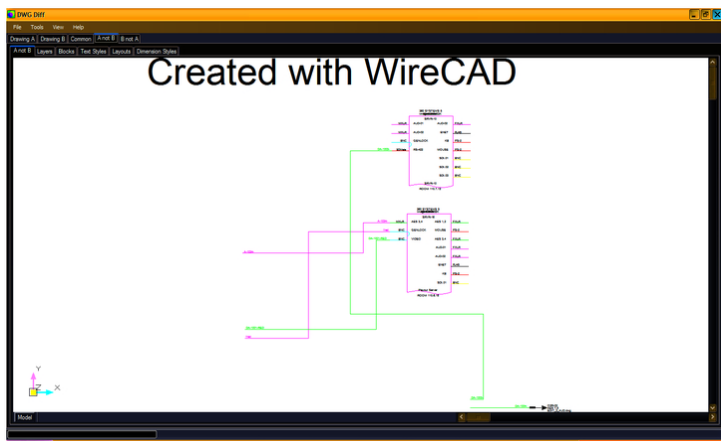

Entities in B but not A

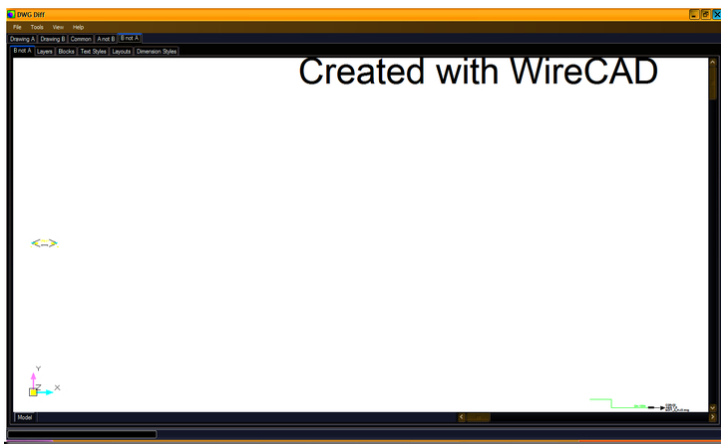

8.6.1.2 Functions

Menu Items

File>Open A: Open the A drawing.

File>Open B: Open the B drawing.

Tools>Calculate Differences: Does the work.

Compares the selected drawing space eg: Model or Layout.

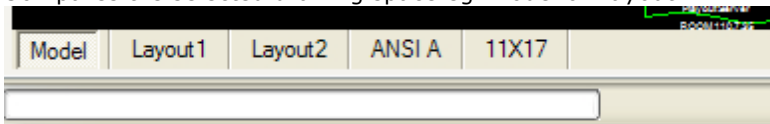

View>Zoom Extents: Zoom the selected space to the extents of all entities.

Help>Help: Displays this file.

Help>Software Activation... : Displays the activation screen.

Help>About: Displays the about screen that show version information etc.

Right-click Context Menus

The following menus are available from all drawing spaces:

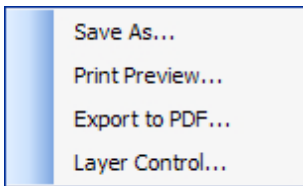

8.7 Brother P-Touch

8.7.1 Introduction



Welcome to the WireCAD plugin for Brother P-touch Electronic Label printers. This plugin supports any of the P-touch printer drivers for Windows, and works in conjunction with the stock P-touch .lbl template formats.

For best results this plugin should be installed in conjunction with at least one P-touch printer driver (follow the instructions with the printer) and the P-touch editor v4.1 or better. For the latest drivers and software, visit the Brother website at www.brother.com

In order to work properly the Brother_PTtouch.Plugin.dll file and support folders must be installed in the WireCAD6\bin folder. Place the BrotherPTouch.wpi file in WireCAD6\bin\plugins folder.

The minimum WireCAD build version to work with this plugin is 6.0.1400

This plugin assumes that you have data in your Project Cables or Project Systems database.

8.7.1.1 Data Page

This plugin has the ability to pull from either the Project Systems database or the Project Cables database. Upon selection of the desired database, you have the ability to apply filters to narrow the selection set. These filters work like the other filters in WireCAD. Click the **<Edit Filter>** button and the filter dialog will be displayed; then select the field, conditional operator and value. Next click the **<Apply Filter>** button.

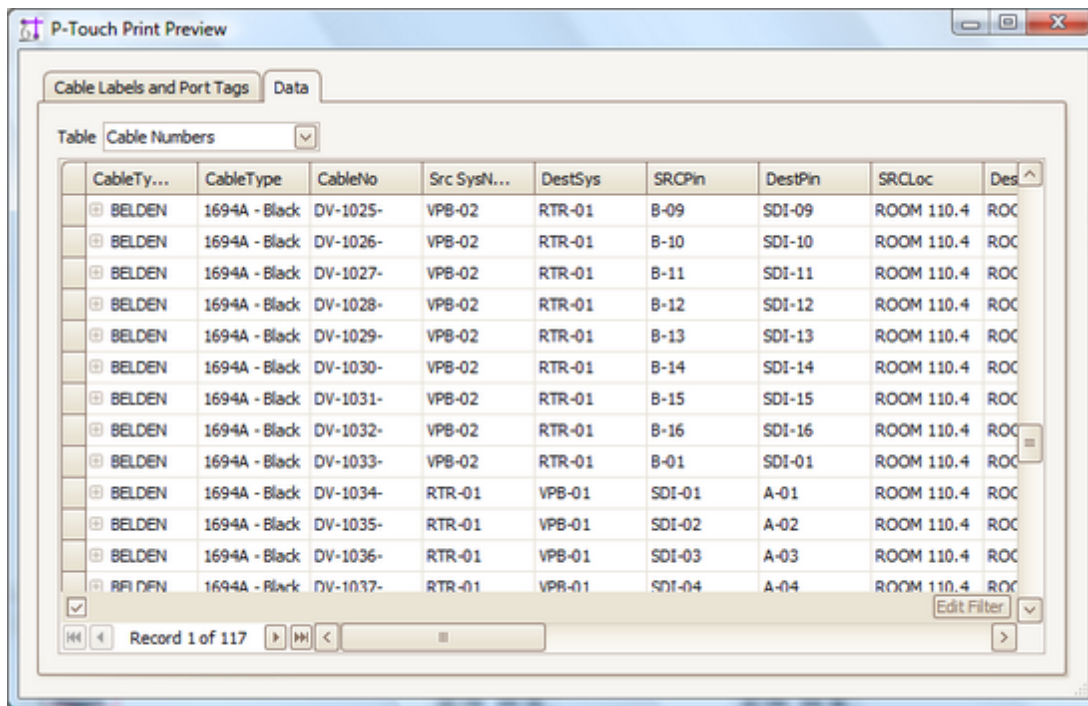

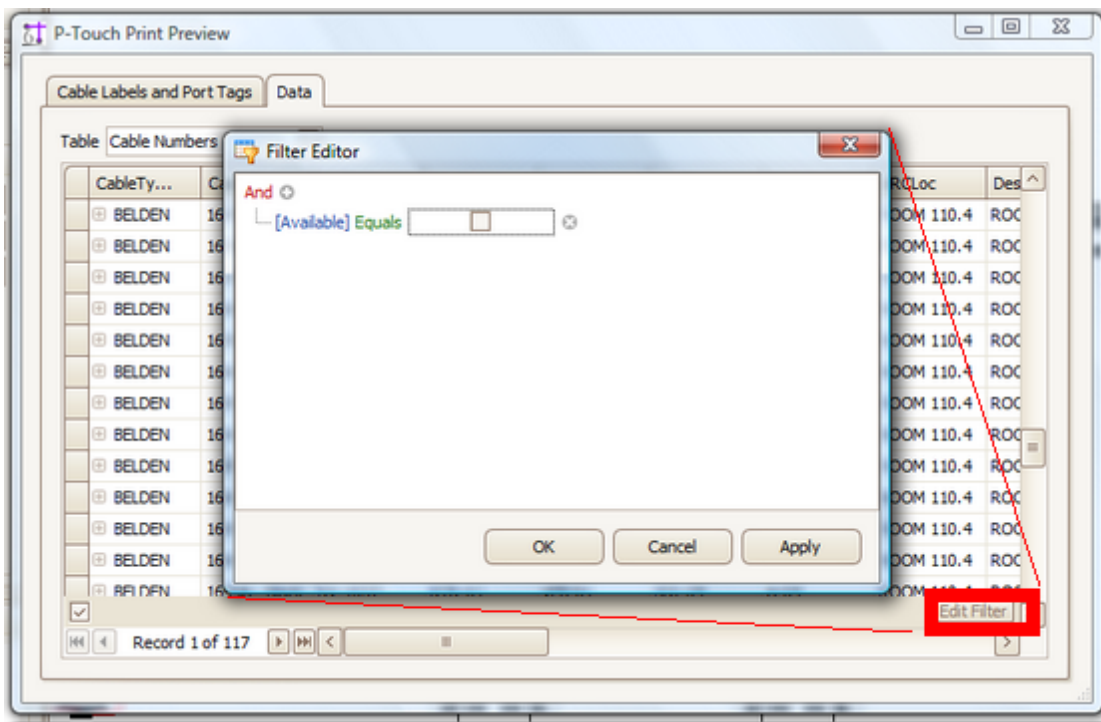
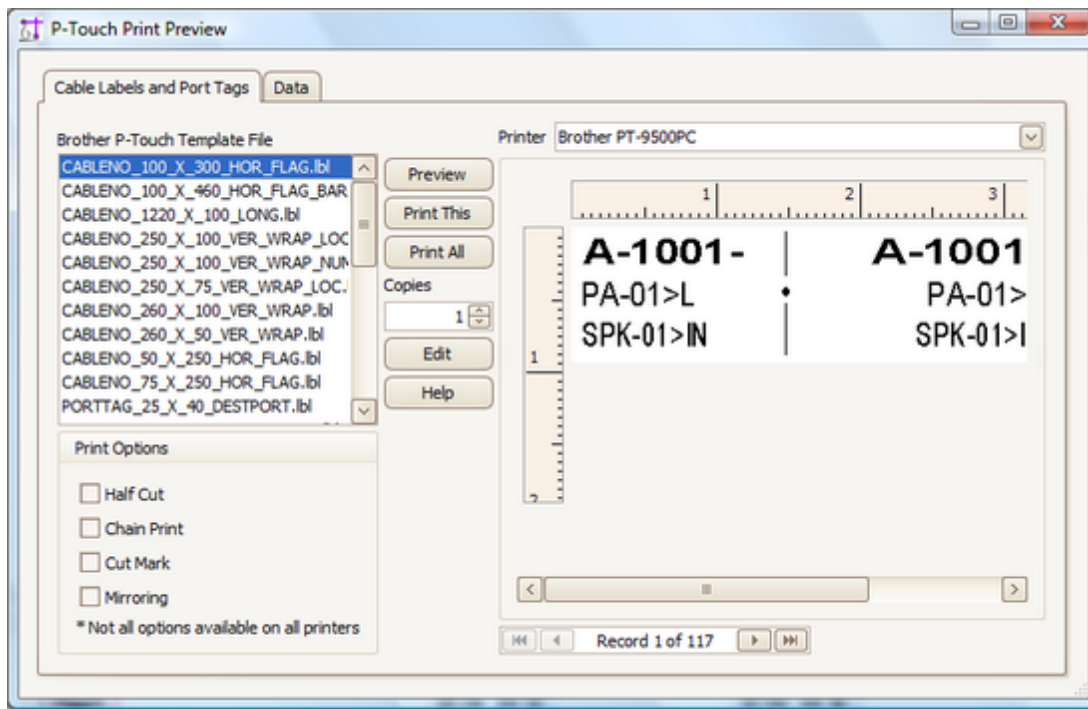

Table: Combo. Selects either the Cables database or the Systems database.

Note: the data grid is read only.

8.7.1.2 Print Cable Labels and Port Tags

From this page you select the template file into which you will print the selected data.



Template File: listbox enumerates all *.lbl files in the {WireCAD Common App Data}\Plugins\Brother Ptouch\Templates\ folder.

<Preview>: Load the selected record into the selected template file and display it.

<Print All>: Prints the entire recordset to the printer.

<Print This>: Prints the selected record.

<Edit>: Launches the P-touch editor (if installed).

Copies: textbox: Enter the number of copies to print.

Preview: pane. Displays a preview of the selected record.

Record Selectors:

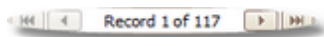

Navigate through the recordset.

Printer Options:

Half Cut: If supported on the printer, will only cut through half of the label creating a roll of labels that can be torn off in the field. This is available on the industrial series printers like the PT-9500 and is really slick.

Chain Print: No space between label prints, nor feed or cut at the end.

Cut Mark: Prints a cut mark.

Mirroring: Inverts text.

Note: the .lbl file contains the info for the printer for which it was created. If you have multiple P-touch units attached to your computer, the report will attempt to print to the unit defined in the .lbl file.

8.7.2 Database Field Rules

This plugin extends the capabilities of the .lbl file. The plugin will evaluate field expressions and insert(merge) text values from any of the database fields into the label.

In order to evaluate properly, the field name must be enclosed in square braces **[fieldname]**.

Text that is not to be replaced is entered normally.

Text that is to be evaluated and replaced is contained in a string that starts with the = symbol and contains at least one field definition.



In the above example, the text strings "**Alias:**" and "**SysName:**" will print as shown. The text strings starting with the = symbol will be replaced by the data from the fields in the current record.

Further, assuming that the field **[alias]** contains the data "**3/4-01**" and the field **[sysname]** contains "**3/4-01**", the label will print as follows:

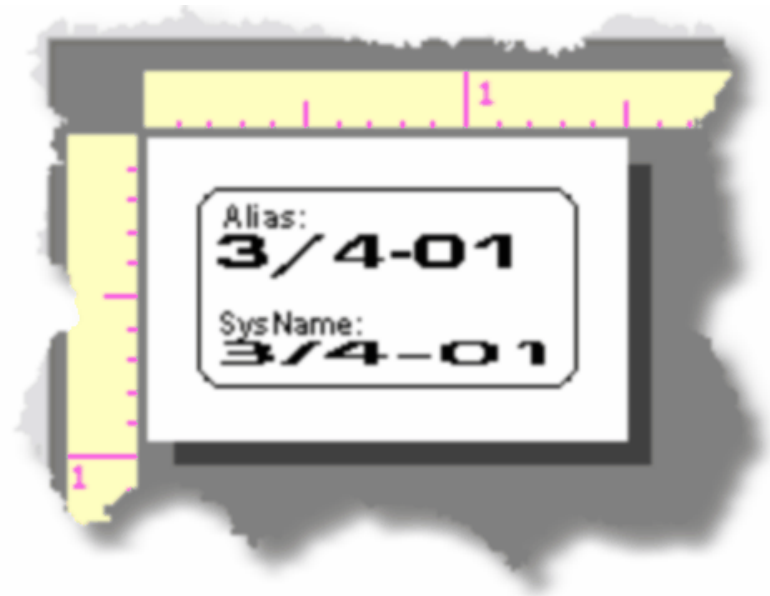

Any characters **not** enclosed in square braces "[]" will be printed as shown.

8.7.2.1 Cable Number Fields

The following is a list of the available Cable Number fields that are available for use in the label:

<i>Field Name</i>	<i>Description</i>
Avai l abl e	True/False. True = the cable number is available and will show up in the available cables list of the Ver i f y Set t i ngs dialog.
Avai l abl eCor es	True/False. Deprecated. Not used.
Cabl eI D	Unique Key. If this is visible, do not change it. Deprecated. Not used.
Cabl eGUI D	Unique Key (GUID)
Cabl eNo	The cable number. See the Project Cable Number Format Dialog.
Cabl eNoPr ef i x	Used with V3 cable number format.
Cabl eNoSuf f i x	Deprecated. Not used.
Cabl eType	Cable part number
Cabl eTypeManu	Cable manufacturer
Ckt Dst	Future. Do not use
Ckt I D	Future. Do not use
Ckt No	Future. Do not use

Ckt Src	Future. Do not use
CreatedBy	Who made the cable.
DateModified	When entry was modified last.
DateOriginated	When entry was first created.
Dest Conn	Destination Connector
Dest Loc	Destination Location
Dest pin	Destination Port
Dest Sys	Destination SysName
Dst Alias	Destination Alias
Integrator	User field.
Length	Manually enter a length or assign a named path and automatically generate a length.
Multicore	True/False. Is it a Multicore cable
NamedPath	A named path. See the Named Paths database.
ProjectRevision	Inherited from the Global Projects database.
ReplacedBY	Not used.
SHEET	The drawing file name.
Signal Type	Signal Type
SRCAlias	Source Alias
SrcConn	Source Connector
SrcLoc	Source Location
SrcPin	Source Port
SrcSys	Source SysName
User 1	It's up to you.
User 2	It's up to you.
User 3	It's up to you.
User 4	It's up to you.

8.7.2.2 SysName Fields

The following is a list of the available SysName fields that are available for use in the label:

Field Name	Description
Alias	The friendly or functional name for this device

Conf l i c t	Conflict resolution mode. Conflicts arise when two devices that are marked IsSequential are connected together. At this point we must discard one of the numbers.
Cur r e n t P r o j e c t R e v i s i o n	Inherited from the Global Projects database.
Dat e A d d e d	The date created.
Dat e M o d i f i e d	Last Modified.
E l e v a t i o n	The E l e v a t i o n element of the location data.
Equ i p m e n t N a m e	Equipment Name
I s S e q u e n t i a l	Reserve a sequential number for each input and output regardless of connection state. Not currently used.
Locat i o n	The Locat i o n element of the location data. The Location and Elevation fields will be concatenated together using the System Location Delimiter to create the Location data. ex Room 101.Wall, or 101-11.12
Manuf act ur er	Manufacturer name.
SysName	The name element of the sysname.
User 1	For you.
User 2	For you.
User 3	For you.
User 4	For you.

8.7.3 More about the .LBL file

The lbl file is Brother's template file for the P-touch electronic labeling systems for PC. Therein you define the look of the printed output.

Some important points to remember:

1. The lbl file contains printer specific information.
2. If the printer for which the lbl file was created is not found on your machine and you have only one P-touch printer driver on your machine, the label will print to that machine.
3. If you have multiple P-touch device drivers installed on your machine and the one for which the lbl file was created is not found you will receive an error stating that the printer cannot be found. Switch to the P-touch editor and change the printer settings to one of the installed drivers.

Part

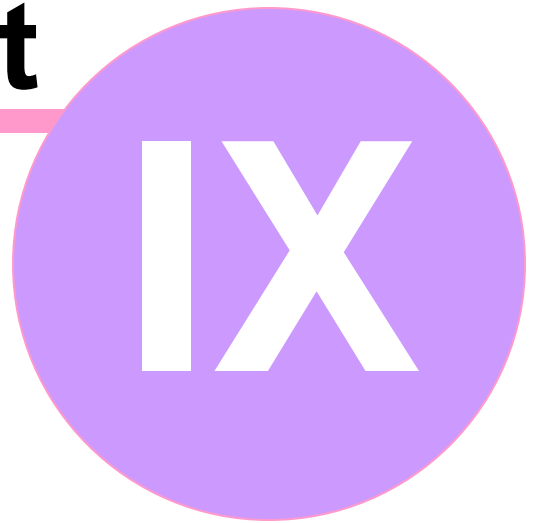

9 CAD Basics

9.1 What is CAD ?

Description

What is CAD/CAM?

CAD Computer Aided Design or Drafting. Inputting lines, arcs, coordinates, dimensions and text for engineering purposes not onto paper but into a data base. The beauty of this is the ability to manipulate the data in many ways during and after completion of any job. There are many types of CAD systems and brand names, but you can break it down into two types, 2D and 3D.

2Dimensional almost like drawing on a drafting board, essentially a flat view usually dimensioned and detailed to some type of standard but is somewhat limited. 3Dimensional is very popular, and with the ability to manipulate 3D Models as if they were actual solid objects, very desirable. Each 3D model is an exact replica of an existing object or idea of an object but in digital format which can be up scaled or down scaled or modified to any specific tolerance. These digital objects are then ready for multiple views, or cross sections, dimensions and details, just like 2D drawings. But 3D models have much more to offer, NC programming can be done to create actual products, see CAM, or even for graphic development for the animation industry, which is also very popular.

CAM Computer Aided Manufacturing, in some cases the manufacturing of parts, fixture gauges, stamping dies, prototype models, moulds etc. The relation to Mach9 Technologies Inc. is not so much Manufacturing but more Computer Aided.

CAM the use of computer generated 3D models, see CAD, to develop specific programs for any particular solid object. Creating a program, cutter path, for an Numeric Control (NC) machine is the most widely used format for cutting various forms, shapes and contours into various materials such as steel, aluminum, tool board, wood, and machinable waxes. There are many other ways to cut materials which are computer controlled as well, and these processes are highly sophisticated in each of their aspects. NC machines are everywhere producing products every day.

Remarks

The term CAD/CAM is a shortening of Computer-Aided Design (CAD) and Computer-Aided Manufacturing (CAM). The term CAD/NC (Numerical Control) is equivalent in some industries.

Well before the development of Computer-aided Design the manufacturing world adopted tools controlled by numbers and letters to fill the need for manufacturing complex shapes in an accurate and repeatable manner, especially for aircraft components. During the 1950's these Numerically-Controlled machines used the existing technology of paper tapes with regularly spaced holes punched in them (think of the paper roll that makes an old-fashioned player piano work, but only one inch wide) to feed numbers into controller machines that were wired to the motors positioning the work on machine tools. The electro-mechanical nature of the controllers allowed digital technologies to be easily incorporated as they were developed.

By the late 1960's Numerically-Controlled machining centers were commercially available incorporating a variety of machining processes and automatic tool changing. Such tools were capable of doing work on multiple surfaces of a workpiece, moving the workpiece to positions programmed in advance and using a variety of tools - all automatically. What is more, the same work could be done over and over again with extraordinary precision and very little additional human input. NC tools immediately raised automation of manufacturing to a new level once feedback loops were incorporated (the tool tells the computer where it is, while the computer tells it where it should be). What finally made NC technology enormously successful was the development of the universal NC programming language called APT (Automatically Programmed Tools). Announced at MIT in 1962, APT allowed programmers to develop postprocessors specific to each type of NC tool so that the output from the APT program could be shared among different parties with different manufacturing capabilities. The development of Computer-aided design had little effect on CNC initially due to the different capabilities and file formats used by drawing and machining programs, but as Cad applications such as SolidWorks and AutoCad incorporate Cam intelligence, and as Cam applications such as MasterCam adopt sophisticated Cad tools both designers and manufacturers are now enjoying an increasing variety of capable Cad/Cam software. Most CAD/CAM software was developed for product development and the design and manufacturing of components and molds, but they are being used by architects with greater frequency.

CAD/CAM software utilizes Cad drawing tools designed ultimately to describe geometries in such a manner that they can be extracted by the Cam portion of the program to define a toolpath that will direct the motion of a machine tool to machine the same shape that was drawn.

Today, over three-quarters of new machine tools incorporate CNC technologies. These tools are used in every conceivable manufacturing sector, including many affecting building technologies. CNC technology is related to Computer-Integrated Manufacturing (CIM), Computer-Aided Process Planning (CAPP) and other technologies such as Group Technology (GT) and Cellular Manufacturing. Finally, Flexible Manufacturing Systems (FMS) and Just-In-Time Production (JIT) are important concepts made possible by Numerically-Controlled Machines, affecting the integration of manufacturing cells, productivity and quality in a wide variety of strategic industries.

9.2 Drawing Entities

Description

Drawing objects are all the objects that are seen on a drawing, like lines, circles etc.

Each one of them are specified by their geometry.

Remarks

These objects can be :

- [Line](#)^[120]
- [Circle](#)^[121]
- [Polyline](#)^[122]
- [Arc](#)^[123]
- [Dimension](#)^[123]
- [Image](#)^[124]
- [Polyface](#)^[127]
- [PolyHatch](#)^[127]
- Rectangle
- [Ellipse](#)^[127]
- [Text](#)^[128]
- [Insert](#)^[129] of block
- [3DFace](#)^[129]

9.2.1 Line

Description

A single line segment.

Lines can be one segment or a series of connected segments, but each segment is a separate line object.

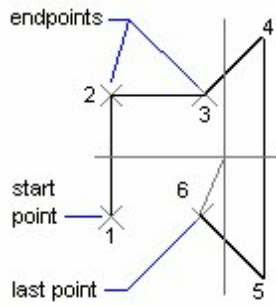

Use the line object if you want to edit individual segments.

Remarks

Line is specified by two points, the Start point and the End point.

When the line has thickness then the extrusion vector of the line defines the direction of the thickness.

9.2.2 Circle

Description

A full circle is defined by its CenterPoint and its Radius.

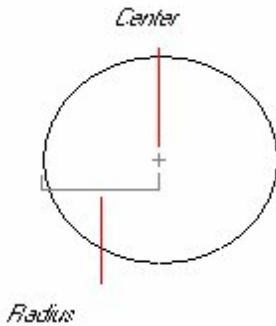

Circle is drawn in the plane that is defined by CenterPoint and ExtrusionVector.

Remarks

Ways to design a circle:

Center,Radius

With this method user sets the center point and the radius of the circle

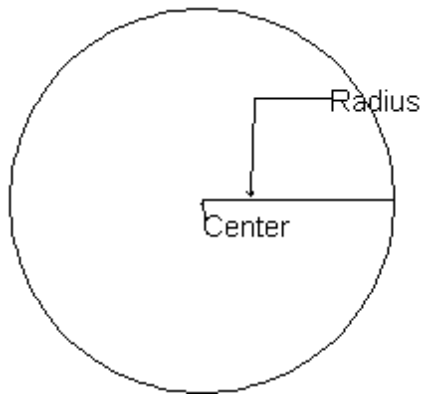

2 Points

With this method user sets two opposite points of the circle. Basically the two points define the diameter of the circle (position and size).

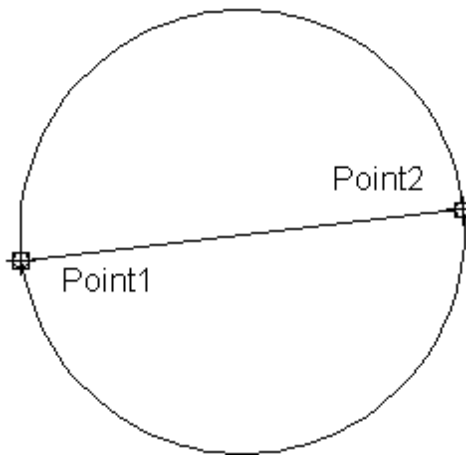

3 Points

With this method user sets three points that belong to the circle.

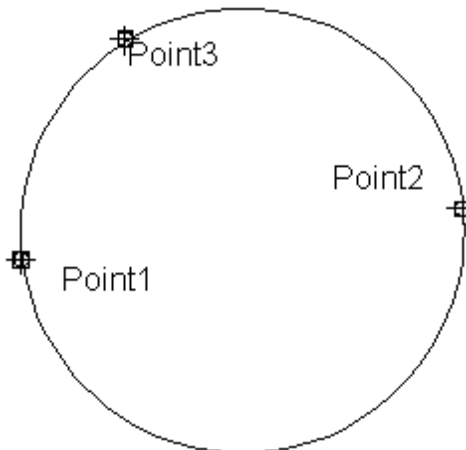

9.2.3 Polyline

Description

This object is a 2D/3D line composed of line and arc (bulges) segments. Polyline is specified by an array of Vertexes (points). When the Polyline has thickness then the extrusion vector of the polyline defines the direction of the thickness.

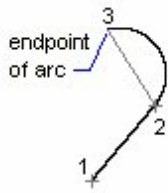

Polyline can be Open or Closed, can be SPLine and be filled with a color or a hatch.

Remarks

Bulge Geometry :

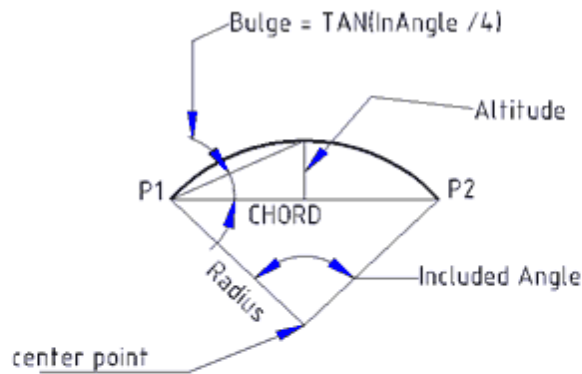

```

chord= SQRT((P2x - P1x)^2 + (P2y - P1y)^2)
Bulge = 2 * Altitude / chord = {TAN(IncludedAngle / 4)}
Altitude = radius - (radius * cos(IncludedAngle / 2.0))
radius = ((chord / 2.0) * (chord / 2.0) + (altilude * altilude)) / (2.0 * altilude)
IncludedAngle = atan(chord / 2.0 / sqrt(radius^2 - (chord / 2.0)^2)) * 2.0
Arc_Length = IncludedAngle * radius
  
```

Bulge sign in PolyLines

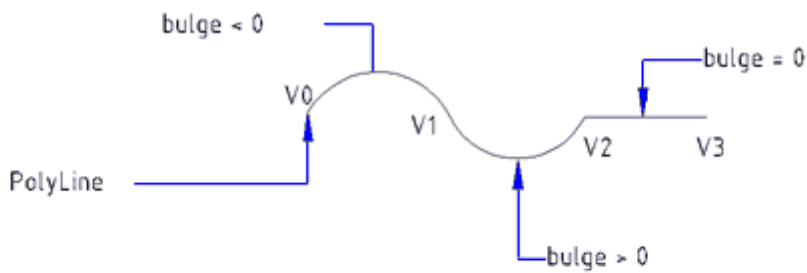

Opposite direction...

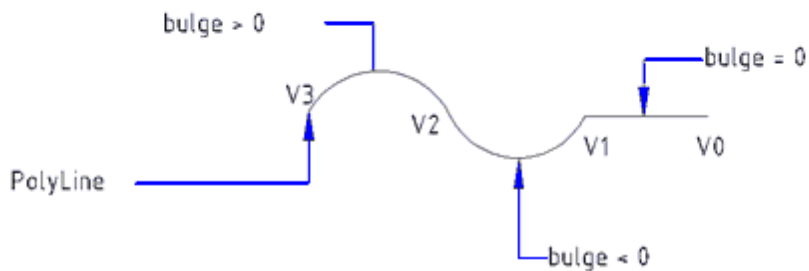

9.2.4 Arc

Description

A circular arc is defined by the center point, the radius, the start angle and the end angle.

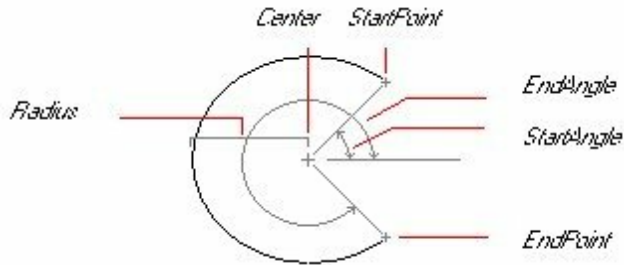

An arc is always drawn anti-clockwise from the StartAngle to the EndAngle.

The StartPoint and EndPoint properties of an arc are calculated through the StartAngle, EndAngle and Radius properties.

The ExtrusionVector is always vertical to the arc. Arc is drawn in the plane that is defined by CenterPoint and ExtrusionVector

Remarks

Ways to design an arc:

Center Point,Radius,Start Angle,End Angle

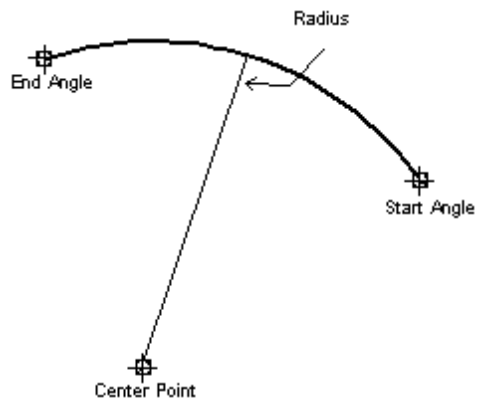

With this method user has to set Center Point,Radius,Start angle and End angle of the arc



With this method user has to set 3 points of the arc

9.2.5 Dimension

Description

Dimensioning is the process of adding measurement annotation to a drawing. User has many ways to

dimension objects and many ways to format dimensions. You can create dimensions for a wide variety of object shapes in many different orientations. You can create dimension styles to format dimensions quickly and ensure that dimensions in your drawing conform to industry or project standards.

Dimensions show the measurements of objects, the distances or angles between objects, or the distance of a feature from an origin you specify. User has three basic types of dimensioning: linear, radial, and angular. Dimensions can be horizontal, vertical, aligned, rotated, angular. A linear dimension measuring the distance between two points which is displayed parallel to the points being measured. In aligned dimensions, the dimension line is parallel to the extension line origins. The extension line origins are specified using the DefPoint1 and DefPoint2 properties.

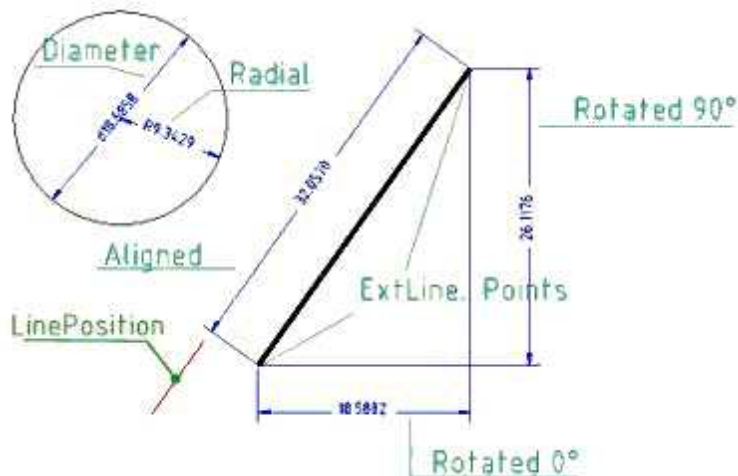

Angular dimensions measure the angle between two lines or three points.

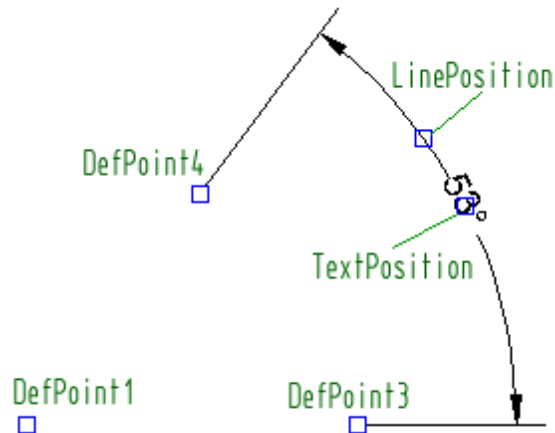

9.2.6 Image

Description

It is a basic object for inserting images in the drawing. Inserted Images can be BMP, GIF, JPG, PNG and TIFF

When the inserted image is an 1-bit Image (B&W) then the background color of the image (usually the white) is shown transparent and the other color is shown black or white, depending on the background color. This is useful for drawings to be scanned and then inserted as images in other drawings.

Image has a Scale property that is used to resize keeping the aspect ratio of the image.

The image is defined by InsertionPoint, Rotation, Width and Height.

9.2.7 Polyface

Description

User defines a PolyFace by specifying each vertex and then associating those vertices with faces in the mesh.

In essence , polyface is a number of 3dfaces combined to an object.

User can explode the polyface into 3dfaces.

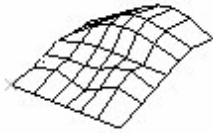

User can create complex 3D objects.

9.2.8 PolyHatch

Description

Polyhatch is a collection which contain PolyLine Objects.

Every PolyLine represents one Hatch which can be excluded from the whole collection or be included to the collection. You can control this using CombineList property. If the CombineList index = 16 then it is excluded else it is included.

Remarks

You can Use Item, Count methods and for each to access the PolyLine Objects of Polyhatch object. When your drawings have Polyhatch objects and are saved in third party formats then Polyhatches are converted to Hatches and vice versa.

Polyhatch objects do not have thickness.

Polyhatch objects in 3D are displayed as solids filled with the FillColor.

9.2.9 Ellipse

Description

An ellipse is defined when we know:

- a) length of axis 1 and the end point of axis 2
- b) center point and the end points of the two axis.

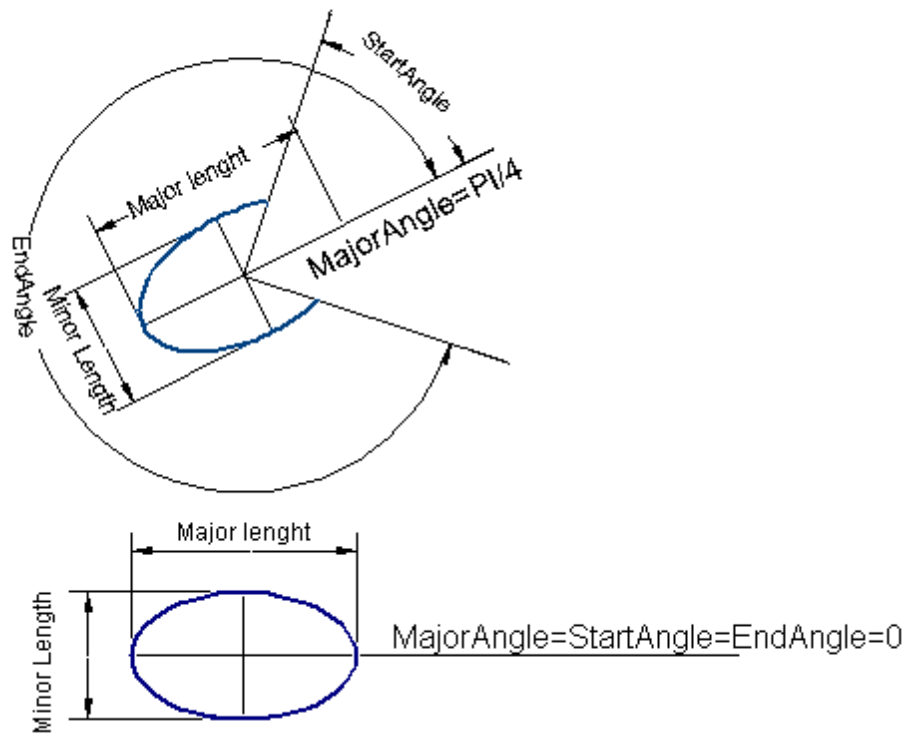

9.2.10 Text

Description

If you want to add a text in the drawing you can use the text command.

You have to set the start point where the text will begin. Then you have to set the rotation angle of the text. After that you can specify the text. Notice that the text will be drawn with the current Text Style of the document.

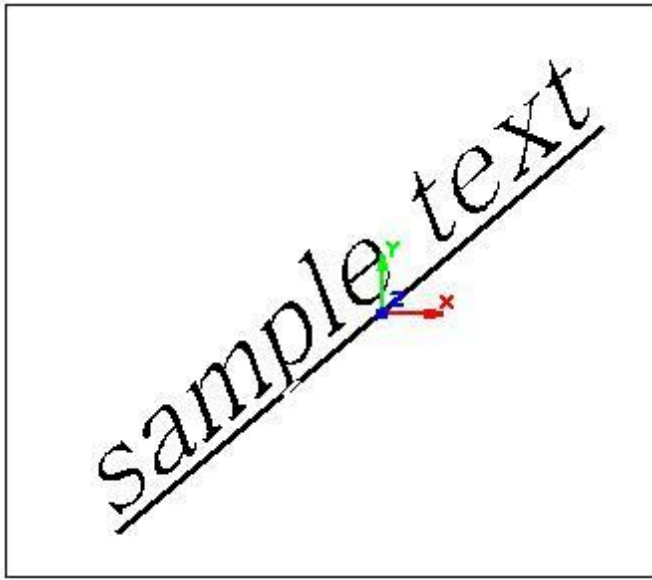

9.2.11 Insert

Description

Places a drawing or a named block into the current drawing.

When you insert a block, you determine its location (or its name if it exists in the drawing), scale factor, and rotation angle. Inserting a block creates an object called a block reference because it references a block definition stored in your current drawing. Notice that in order to insert a block, this must be an existing block that previously has been created or that it will exist as an independent drawing.

Remarks

The insert object can be exploded to the objects that consist of.

9.2.12 3DFace

Description

3dface creates a three or four sided surface anywhere in 3D space. You can specify different Z coordinate values for each corner point of a 3D face.

Remarks

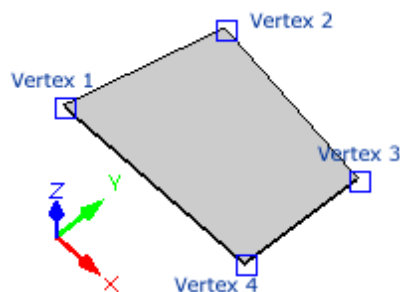

Is an object which have a vertexlist with 4 items as Point(x,y,z) in World CS.
The fourth point can be the same as first (to make a triangle).

9.3 Collections

Description

The Collections are very important. The drawing objects (lines, text, dimensions etc) take their properties, when they are created, from these collections. The collections are:

- [Layers](#)^[130]
- [Layouts](#)^[132]
- [TextStyles](#)^[133]
- [DimStyles](#)^[133]
- [Blocks](#)^[134]
- [Lights](#)^[135]
- [Selections](#)^[135]
- [Section Clips](#)^[135]
- [Linetypes](#)^[136]
- [Lineweights](#)^[137]

9.3.1 Layers

Description

Layer is the equivalent of the overlay used in paper-based drafting. It is the primary organizational tool in the WireCAD CAD space, and you can use it to group information by function and to enforce linetype, color, and other standards.

Organizing Layers and the objects on Layers make it easier to manage the information in your Drawings.

When you put one layer over another then the result is the complete drawing.

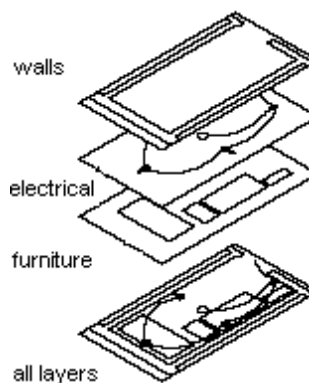

Having kindred objects on the same layer it is very helpfull in order to organise the drawing.

Properties:

- layer name
- color of the entities
- line type of the entities
- line weight of the entities
- if it is participate or not in the drawing(thawed or frozen)

- locked or not

Remarks

When you begin a new drawing, WireCAD creates a special layer named 0. By default, layer 0 is assigned color number 7 (white or black depending upon your background color), the CONTINUOUS linetype and a linewidth of Default (the default setting is .01 inch or .25 mm). Layer 0 cannot be deleted or renamed.

All new objects are added to the active layer if no layer is specified.

Using the Layers editor you can Freeze (Hide), Thaw (Show) and Lock layers.

By controlling whether a Layer's state is Thaw or Frozen you can change the appearance of your drawing to display only the information on the Layers that are visible. Freezing unused Layers will help the performance of WireCAD.

In the drawing below (Picture 1) there are 3 types of items : **walls** (the lines and Polylines with red color), **doors&windows** (Blue color) and **furniture** (Magenta).

These objects are teamed and drawn in different layers. Walls placed on layer "WALLS", Doors&windows are placed on layer "WIN_DOORS" and furniture are placed on layer "FURNITURE".

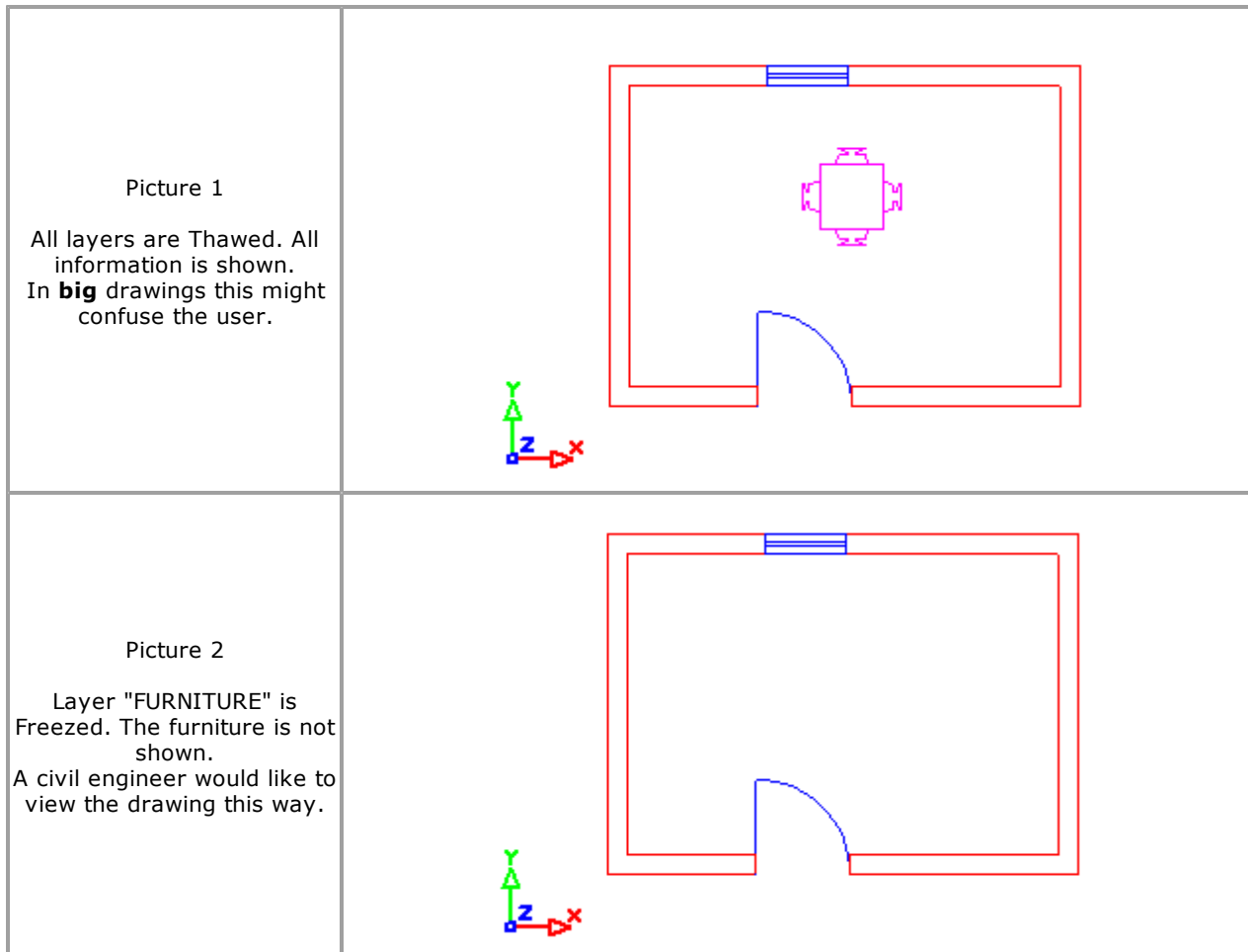

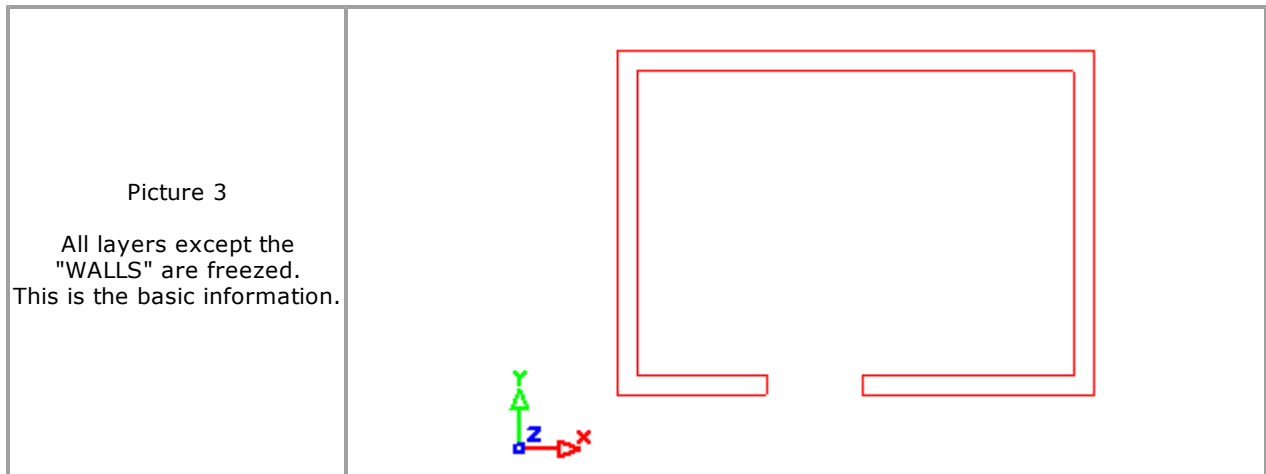

9.3.2 Layouts

Description

Layout is used to compose or lay out your model drawing for printing. A layout may consist of a title block, one or more viewports, and annotations. As you create a layout, you can design floating Viewport configurations to visualize different details in your drawing.

A layout is a paper space environment that simulates a sheet of paper. In a layout, you can create and position viewport objects, and you can add a title block or other geometry. You can create multiple layouts in a drawing to display various views. Each layout displays the drawing as it will be printed on the sheet of paper.

Typically, when you begin designing a layout environment, you step through the following process:

- Create a model drawing.
- Activate or create a layout.
- Insert a title block.
- Create floating viewports and position them in the layout.
- Set the view scale of the floating viewports.
- Print your layout.

Remarks

Sample of a Layout (Paper Space) :

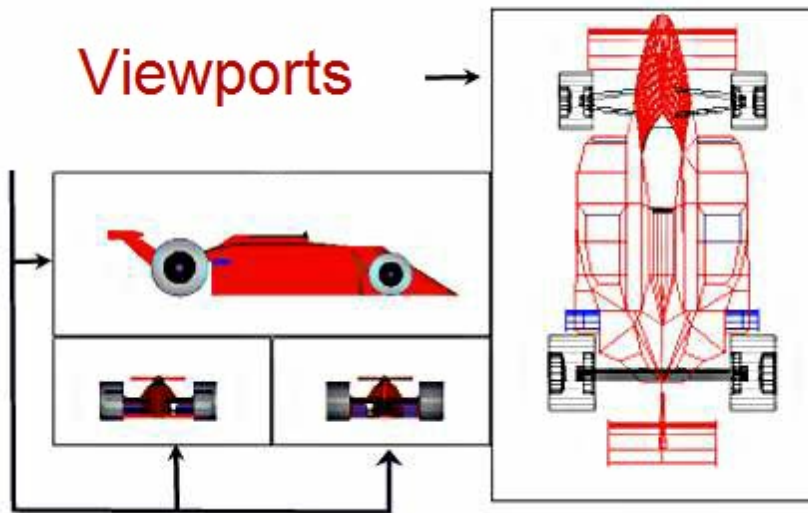

9.3.3 TextStyles

Description

TextStyle is a named, saved collection of settings that determines the appearance of text strings.

You can create your own text styles which can have specific fonts and text height. You can also specify if the [text](#)^[128] will be underlined, bold etc.

There is no limit to the number of text styles you can create in your drawing.

Remarks

The active text style determines the appearance of new text created in the drawing. StyleName of text object will get the value of ActiveTextStyle property.

When you enter text, it uses the current text style, which sets the font, size, and other text characteristics. If you want to create text using a different text style, you can make another text style active.

9.3.4 DimStyles

Description

A dimension style is a group of dimension settings that determines the appearance of a [dimension](#)^[129].

Remarks

The active dimension style determines the appearance of new dimensions created in the drawing. To change the style of an existing dimension, use the StyleName property found on the dimension.

When you create a dimension, the current dimension style is associated with that dimension. The dimension retains this dimension style unless you apply a new dimension style to it or set up dimension style overrides.

The picture below shows where the *vdDimstyle's* properties apply to *vdDimension* objects.

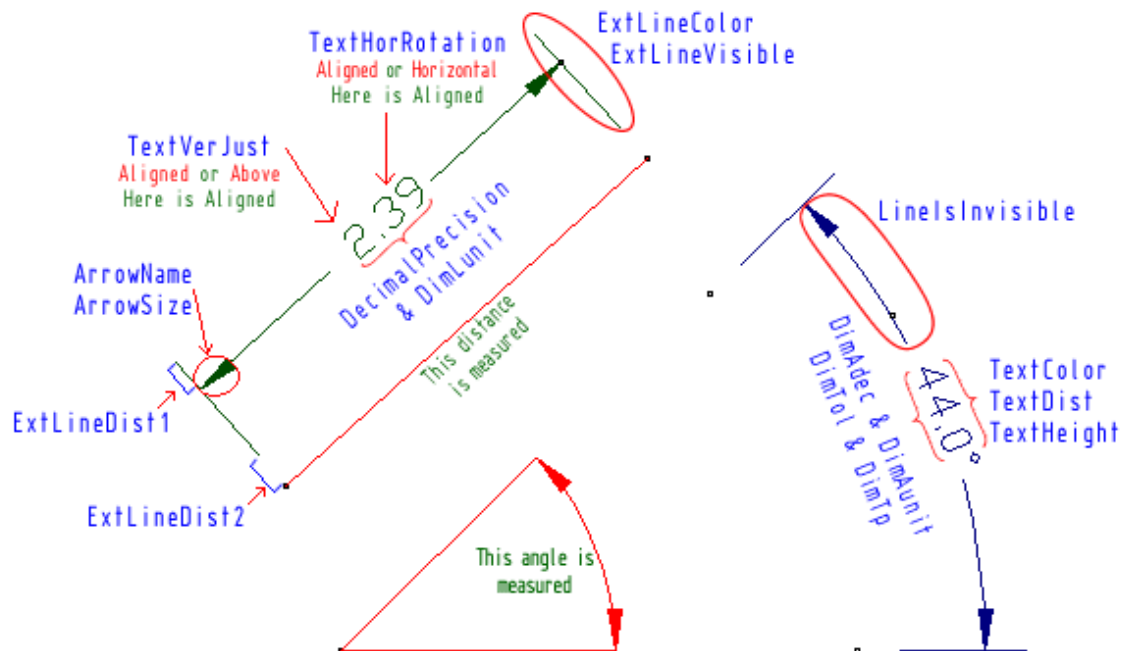

9.3.5 Blocks

Description

A block is a collection of objects you can associate together to form a single object, or block definition. You can insert, scale, and rotate a block in a drawing. You can explode a block into its component objects, modify them, and redefine the block definition.

Remarks

Blocks streamline the drawing process. For example, you can use blocks to

- Build a standard library of frequently used symbols, components, or standard parts. You can [insert](#)^[129] the same block numerous times instead of re-creating the drawing elements each time.
- Revise drawings efficiently by inserting, relocating, and copying blocks as components rather than individual geometric objects.
- Save disk space by storing all references to the same block as one block definition in the drawing database.

When you [insert](#)^[129] a block in your drawing, you are creating a block instance. Each time you insert a block instance, you assign a scale factor and rotation angle to the inserted block. You can also scale a block instance using different values in any coordinate (X, Y, Z) direction. Blocks make it possible for you to organize your drawing tasks in a systematic way, so that you can set up, redesign, and sort the objects in your drawings and the information associated with them.

9.3.6 Lights

Description

It is the collection of the Lights objects.

Adding lights to your drawing is the simplest way to improve the appearance of your models. You can use lights to illuminate a whole model or to highlight selected objects and parts of objects in your drawing.

Remarks

You can add as many lights you want but you can only enable 8 including the Default Light.

This is an example of a sphere with two lights.

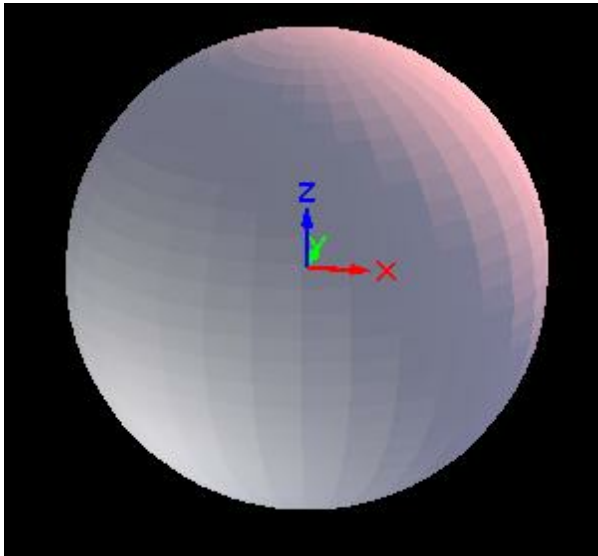

9.3.7 Selections

Description

One or more selected objects that specify a selection for processing as a single unit.

For example instead of copying objects to another location one at a time, you can select all objects and copy the selection once.

Remarks

There is no limit to the number of selection sets you can create in your drawing.

However, there can be only one instance of the SelectionSets Collection.

The SelectionSets Collection object is predefined for each drawing.

9.3.8 Section Clips

Description

WireCAD uses section clipping planes to hide an area of the drawing. This SectionClip defines the side of the drawing that will be visible. The rest will be hidden.

Remarks

The visible plane is defined in the vdSectionClip object by defining the OriginPoint and the Direction vector. The direction of that vector defines the visible area. The area in the opposite direction will be hidden.

Direction with the OriginPoint define the plane that will do the section clipping. Their values are always in World Coordinating System.

Multiple vdSectionClip objects will show the common viewable area of all. This allows an unobstructed interior view of a 3D drawing by hiding the defined area from view.

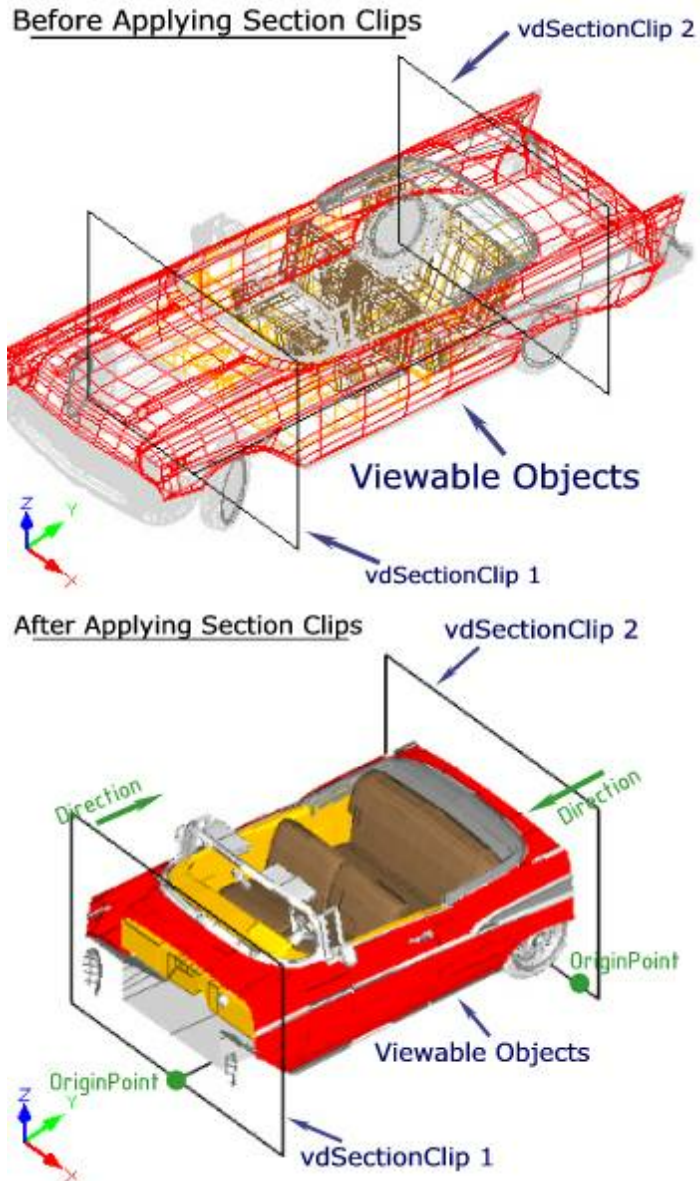

9.3.9 Linetypes

Description

With linytype you can select a specific type for a [line](#)^[120] which all the new lines will be.

Any future object in the drawing will be added with the new selected line type.

TIPS: Instead of changing line type any time you want a different line type, you can create different [layers](#)^[130] with the desirable line type.

Remarks

WireCAD uses penstyle property to define the linetype.

Default value is VdPenByLayer (PenStyle by Layer). When object is a Layer then the default value is VdPenSolid.

Penstyle is scaleable. The scale is set from the ActiveDocument.LineTypeScale property.

If the entity is part of a block and it's layer name is "0" and pen style is VdPenByLayer (by Layer) then, when the block is inserted, entity takes the pen style value of the inserted object. This can be done the same if you use for Penstyle the value VdPenByBlock (by block).

These are some examples of linetypes:

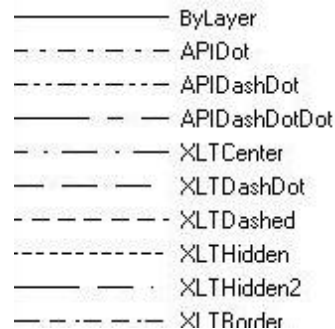

9.3.10 Lineweights

Description

With lineweight you can select a specific width for a line which all the new lines will be.

Using lineweights, you can create heavy and thin lines to show cuts in sections, depth in elevations, dimension lines and tick marks, and varying object thicknesses in details.

Remarks

TIPS: Instead of changing lineweight any time you want a different lineweight, you can create different [layers](#) with the desirable lineweight.

Any future object in the drawing will be added with the new selected lineweight.

In model space, lineweights are displayed in pixels and do not change when zoomed in or out. Thus, you should not use lineweights to represent the exact width of an object in model space. For example, if you want to draw an object with a real-world width of 0.5 inches, do not use a lineweight, instead, use a polyline with penwidth equal to 0.5 inches to represent the object.

9.4 Commands

Description

In order to edit designed objects you have to run the specific command and then select the object(or objects) you want to edit. The same procedure must be done when you want to create new objects from one or more drawing objects.

Alternative, you can choose firstly the objects and then run the command. However not every command accepts preselected objects. Also not every command accepts multiple selected objects.

Remarks

The commands are used to edit the drawing objects, like splitting a line to two smaller lines, delete a circle etc. The commands are the following:

- [Select](#) 

- [Erase](#)^[138]
- [Undo](#)^[139]
- Redo
- [Copy](#)^[139]
- [Offset](#)^[139]
- [Fillet](#)^[140]
- [Move](#)^[141]
- [Trim](#)^[141]
- [Extend](#)^[141]
- [Mirror](#)^[142]
- [Array](#)^[142]
- [Break](#)^[143]
- [Scale](#)^[143]
- Rotate
- [Explode](#)^[144]
- [Purge](#)^[144]
- [Zoom](#)^[144]
- [Pan](#)^[145]
- [View3D](#)^[145]

9.4.1 Select

Description

When you run an edit command (which allows multiple object selection) you have to select the objects(or object) that you want to edit.

There are many ways to select objects:

- You can click one by one the objects you want to select.
- Crossing method. With this method you have to set a rectangle by setting the two opposite corners (first set one of the two right corners) of the rectangle. Then all the objects that are included entirely in the rectangle or have an intersection point with the rectangle , will be selected.
- Window method. It is similar with the crossing method , but only the objects that are included entirely in the rectangle will be selected(Also you have to set one of the left corners of the window).
- Select All. With this method you can select all the objects of the drawing
- Select Last. With this method you can select the last drawn object.
- Select Previous. With this method you can select the objects that was selected before the completion of the last edit command(Notice that previous command does not take effect when the previous command was erase or undo.

Remarks

9.4.2 Erase

Description

With the erase command you can delete one or more objects of the drawing.

If you want to erase multiple objects you have to execute the [select](#)^[138] method.

After the erase command, the objects no more "exist" in the document and in the collection they belonged to, however the objects still exist as "deleted" objects in memory. So with undo command you can get them back to the drawing.

Remarks

9.4.3 Undo

Description

Many times you want to cancel one or more commands that took place. This can be done with the undo command.

You can also undo a group of commands that took place. The group undo takes place by the opposite order. If for example 100 commands were executed, undo command cancels first the 100th command, then the 99th etc.

Remarks

9.4.4 Copy

Description

With copy command you can copy one or more objects of the drawing.

When copy command starts, user has to [select](#)^{F3} objects. Then the user is prompted to select two points. These two points define the "copy vector" and can either belong to the selected objects or not. The first point specifies the beginning of the "copy vector" and the second point the end of it.

Remarks

9.4.5 Offset

Description

With Offset command you can create a new object, in parallel direction and in specified distance from the original object which is used as pattern for the new object.

When you execute offset command, you are prompted to [select](#)^{F3} an object. Then you have to specify the offset distance which is the distance that the new object will be drawn from the original object. Then you have to set the side that the object will be drawn because there are two sides.

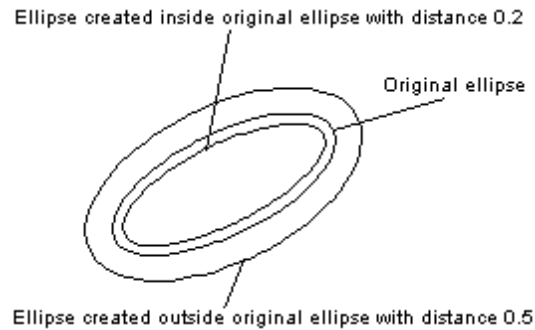

Remarks

9.4.6 Fillet

Description

With the fillet command you can connect two lines, two arcs, or one arc with a line (these two objects must have at least one common point either visible, or in their extension), with an arc with a specific radius. The value of the radius has some restrictions depending on the position of the objects. If radius=0 then simply the objects are either extended until they intersect each other in one point (if there was not an intersection point) either trimmed (if an intersection point is visible).

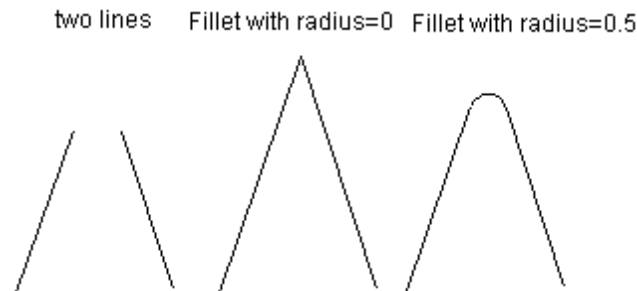

You can also insert fillet arcs at vertex of specified index of a polyline where two line segments meet if the specified radius is enough small to fit into lines.

If the radius is bigger then it is ignored for the specific vertex.

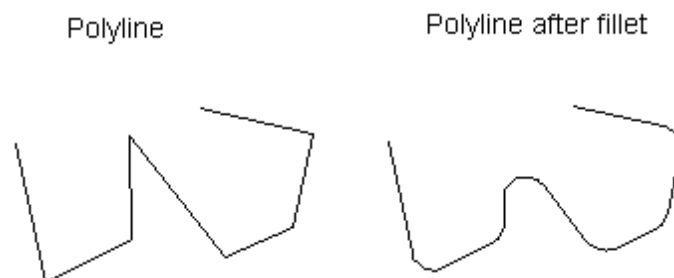

Remarks

9.4.7 Move

Description

With move command you can move one or more drawing objects.

In order to take place the move command you have(after [selecting](#)^[138] the objects or object) to define two points that define the distance and the direction of the movement.

The first point defines the beginning of the "movement vector" and the second the end of the vector.

Remarks

9.4.8 Trim

Description

With trim command you can trim objects at a cutting edge defined by other objects.

First [select](#)^[138] the objects that define the cutting edges at which you want to trim an object and then the object.

Objects that can be trimmed include arcs, circles, elliptical arcs, lines.

Notice that the trim command do not function if the objects do not intersect.

At the example below there are some lines that were trimmed.

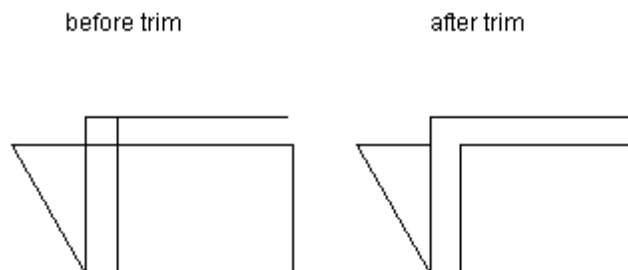

Remarks

9.4.9 Extend

Description

With extend command you can extend lines, arcs, polylines until they intersect with some other object which is used as limit of the extension.

Firstly you have to [select](#)^[138] the objects that consist the limits of the extension. Then you have to choose a point at an object that you want to extend. If the object you want to extend does not intersect with above objects then nothing will happen.

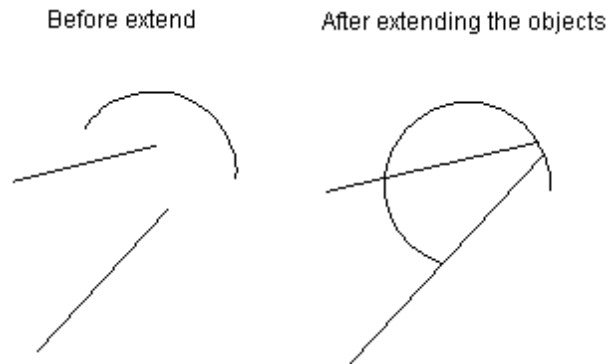

Remarks

9.4.10 Mirror

Description

With mirror command you can create the symmetrical of one or more objects reflected by an axis defined by the user.

First you have to [select](#)^[138] the objects you want to mirror. Then you have to set the axis, by setting the first point of mirror line and then the second. At this point you have to choose if the source objects will be deleted or not.

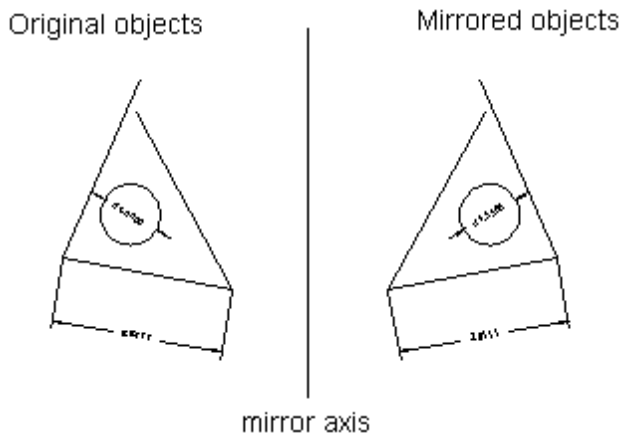

Remarks

9.4.11 Array

Description

Creates multiple copies of objects in a pattern.

There are the Rectangular Array and the Polar Array.

With the rectangular array you can create an array defined by a number of rows and columns of copies of the selected object.

First you have to [select](#)^{F138} the objects. Then you have to define number of rows and number of columns of the rectangle, the distance between rows and the distance between columns.

With the Polar Array you can create an array by copying the selected objects around a center point. First you have to select the objects. Then you have to set the center point and next you have to define the numbers of the copy objects that will be created and the fill angle (if you put for example 360 then the object will be created like in the below example). At the end you are prompt to choose if the object will be rotated or not.

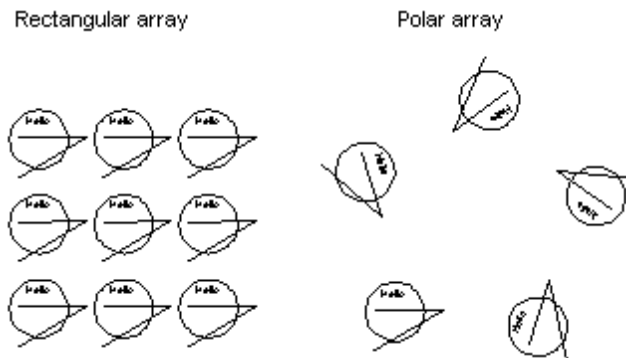

Remarks

9.4.12 Break

Description

With break command you can divide one object into two objects, or you can remove one part of it (this part will be defined by two points that you have to pick).

First you have to [select](#)^{F138} the object. Then you have to define the first break point and the second break point. When you pick this points, the part which is defined by the two points will be deleted from the object.

Remarks

The two points can be the same point. In this case you only explode the object into two other objects (for example you can cut a line into two lines).

If break command runs over a circle, you have to set two different points in order to see a result because a circle cannot break in one point. After break command the circle becomes arcs.

9.4.13 Scale

Description

With scale command you can increase or decrease the size of one or more objects.

First you have to [select](#)^{F138} one or more objects. Then you have to pick one point, which is going to be the base point. Next step is to specify the scale factor.

Remarks

9.4.14 Explode

Description

With explode command you can break compound objects , like [inserts](#)^[129] , [dimensions](#)^[129] , [polylines](#)^[122] etc into their sub entities.

Remarks

Here are some objects that can be exploded:

- vd3DFace explode to one vdPolyline
- vdDimension explode to vdLines, vdText(s), and vdInserts (the arrows)
- vdInsert explode to the entities that is consist of. (If there are Inserts inside Blocks then you may need to apply more than 1 explode to get the simplies entities)
- vdPolyface explode to vd3DFace(s)
- vdPolyHatch explode to vdPolyline(s)
- vdPolyline explode to vdLine(s) and/or vdArc(s)
- vdRect explode to vdPolyline
- vdText explode to vdPolylines(only texts with fontfile SHX).TTF(true type font) texts are not exploded

9.4.15 Purge

Description

With purge command you can reject some tables of the drawing like [layers](#)^[130], [textstyles](#)^[133], [linetypes](#)^[130] etc that you do not use in the drawing and you do not want anymore.

In purge command you have to specify what objects you want to delete(PurgeFlag). You can also see with purge command which tables are not currently used in the drawing.

Remarks

PurgeFlag can be one of the following:

- ALL Removes all unused named objects layers, textstyles, dimstyles, blocks and images.
- LAYERS Removes all unused named layers
- TEXTSTYLES Removes all unused named textstyles
- DIMSTYLES Removes all unused named dimstyles
- BLOCKS Removes all unused named blocks
- IMAGES Removes all unused image information.
- GETLAYERS fills the return value with the array of all unused named layers (the objects still exist)
- GETTEXTSTYLES fills the return value with the array of all unused named textstyles (the objects still exist)
- GETDIMSTYLES fills the return value with the array of all unused named dimstyles (the objects still exist)
- GETBLOCKS fills the return value with the array of all unused named blocks (the objects still exist)

9.4.16 Zoom

Description

Zoom command allows the user to increase or decrease the apparent size of objects , so the user can control the part of the drawing that is included in the screen.

Zoom command is a transparent command.

Transparent commands are commands that can be invoked when another command is active.

Remarks

There are several ways to execute the zoom command:

"E"(Extends) Zooms to display the drawing extents

"P"(Previous) Zooms to display the previous view

"W"(Window) Zooms to display an area specified by two opposite corners of a rectangular window. User must specify these two corners.

"A"(All) zooms to the drawing limits or current extents, whichever is greater.

"S"(Scale) Zooms the display at a specified scale factor. For example, entering 2 doubles the apparent display size of any objects from what it would be if you were zoomed to the limits of the drawing. Entering 0.5 causes each object to be displayed at half its current size on the screen.

9.4.17 Pan**Description**

You can shift the location of your view by using

pan or by using the window scroll bars. Like panning with a camera, pan does not change the location or magnification of objects on your drawing; it changes only the view.

Pan command is a transparent command.











Transparent commands are commands that can be invoked when another command is active.

Remarks**9.4.18 View3D****Description**







With View3D command you can change the current view of the drawing.

Remarks

The View3D function when is called it also changes the Current Coordinate System (CCS) to World Coordinate System (WCS).

Arguments	
Description	Parameter
 Sets the view point to top	VTOP
 Sets the view point to bottom	VBOTTOM
 Sets the view point to left	VLEFT
 Sets the view point to right	VRIGHT
 Sets the view point to front	VFRONT
 Sets the view point to back	VBACK
 Sets the view point to southwest isometric	VISW
 Sets the view point to southeast isometric	VISE
 Sets the view point to northeast isometric	VINE
 Sets the view point to northwest isometric	VINW
 Shades the objects between the polygon faces and displays materials if there are	RENDER

attached on object colors else the result is the same like SHADE

	You can start a continuous motion with it , by rotating the coordinate system around X (vertical motion dy) and/or around Y Axis (Horizontal motion dx)	VROT
	Shades the objects between the polygon faces and does not displays materials. Coloring the objects surfaces with it's colors.	SHADE
	Combines the SHADE and WIRE options	SHADEON
	Displays the objects using 3D wire frame representation and hides lines representing back faces.	HIDE
	Displays the objects using lines and curves to represent the boundaries.	WIRE
	Sets the view point to World system.	VWORLD
	Sets the view point to any angle.	VPOINTANGLE

9.5 Limits

Description

While designing in paper user has a specific space to make the drawing , with CAD user can have unlimited space to design the drawing.

The drawing limits are two-dimensional points in the world coordinate system that represent the lower-left and upper-right boundaries. You cannot impose limits on the Z direction.

Remarks

When limits checking is turned on , the drawing limits restrict the [coordinates](#)^[146] you can enter to within the rectangular area. Drawing limits also determine the area of the drawing that can display grid dots, the area displayed by one of the scale options of

zoom, and the minimum area displayed by zoom all.

9.6 Coordinates

Description

Coordinates are being expressed in drawing units. Drawing units are not expressing particular units(meters, inches etc).

In this part user have to make some assumptions in order to define that the coordinates of the drawing mean particular units(meters,inches etc).

For example:

For a mechanical drawing we can make the assumption for example: where one drawing unit defines one millimeter(1 D.U=1mm)

For a architectural/technical drawing we can make the assumption for example: where one drawing unit defines one meter(1 D.U=1m)

This can be very helpfull in designing,dimensioning,retrieving informations from the drawing(distances,area calculations)

Remarks

9.7 Viewport

Description

Viewports are areas that display different views of your model. As you work, you can split the drawing area into one or more adjacent rectangular views known as *model viewports*. In large or complex drawings, displaying different views reduces the time needed to zoom or pan in a single view. Also, errors you might miss in one view may be apparent in others.

ViewPorts are treated as rectangle drawing objects which display views and can be moved or resized.

They can be created only in entity list collection of a layout and not in Model.

With WireCAD 6.1 you can now attach viewports to closed polygons (polylines, circles, ellipses, rectangles).

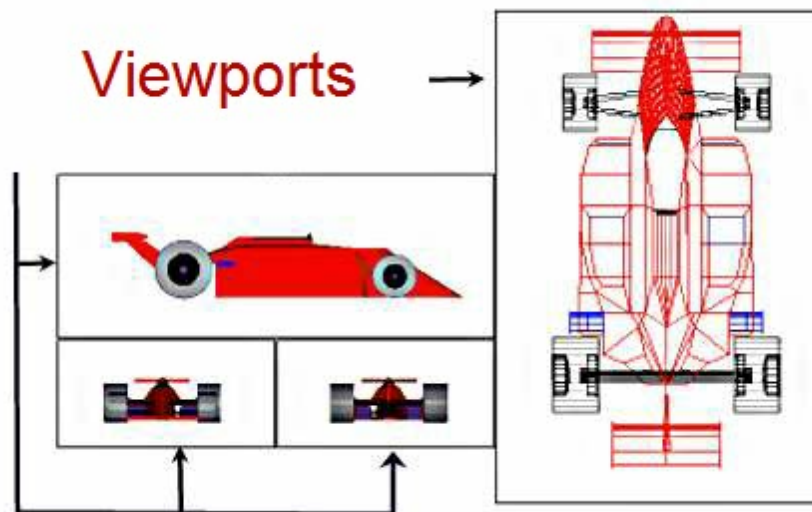

Remarks

Those rectangles filled with the image of the model space objects in different scales depend from the ViewSize and the ViewCenter property. This way in one paper you can print out different views (with different scales) of the same drawing (Model Space) or parts of this drawing.

In viewports commands like Pan, Zoom and View3D of vdCommandAction objects can be applied, only when Viewport is Active (See ActiveViewport property of Layout object) and SpaceMode property of vdLayout has the value SPACEMODE_MODEL.

9.8 Model Space Boundaries

It's a big model space in there. We can, if we are not careful, create a drawing that is so big that it can't be effectively printed or plotted. In order to have some Idea of where the fences are WireCAD can place boundaries in the model space. The boundary is created from the viewport. We use the text height as the terms for our equation. We do this because a drawing is considered readable if we can read the text. If we can't read the text the drawing becomes useless.

In the following example we have created a viewport in our ANSI_A layout that is attached to a closed polyline. The polyline traces the page border that encroaches on the display space. We then create a boundary with our parameters. The results look like this:

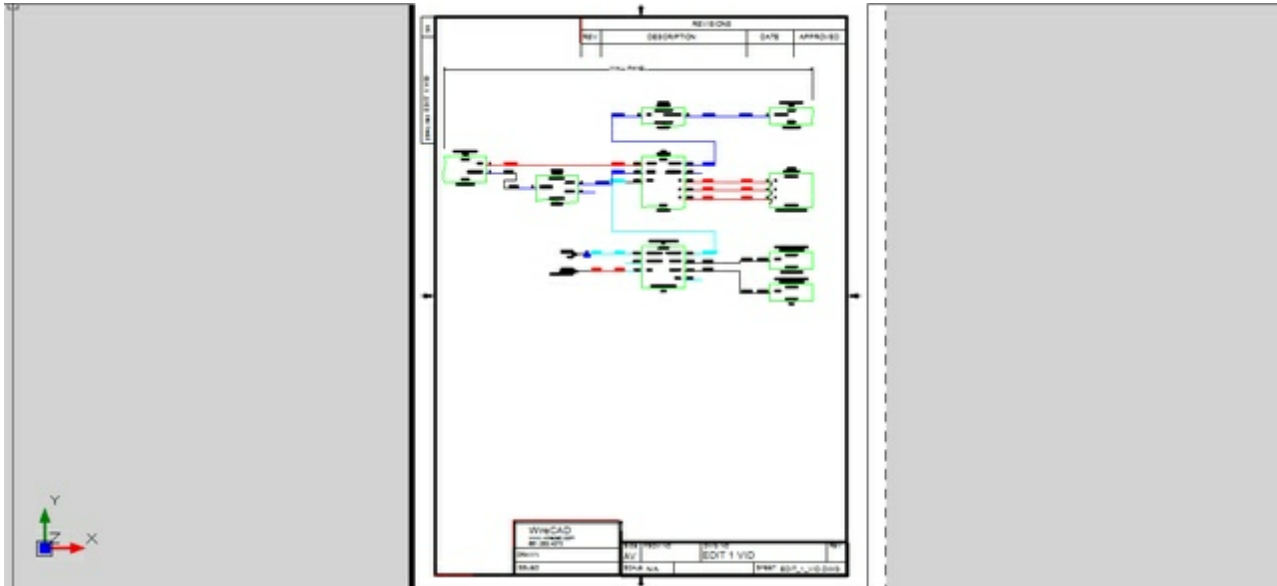

Layout with page border, and polygon viewport

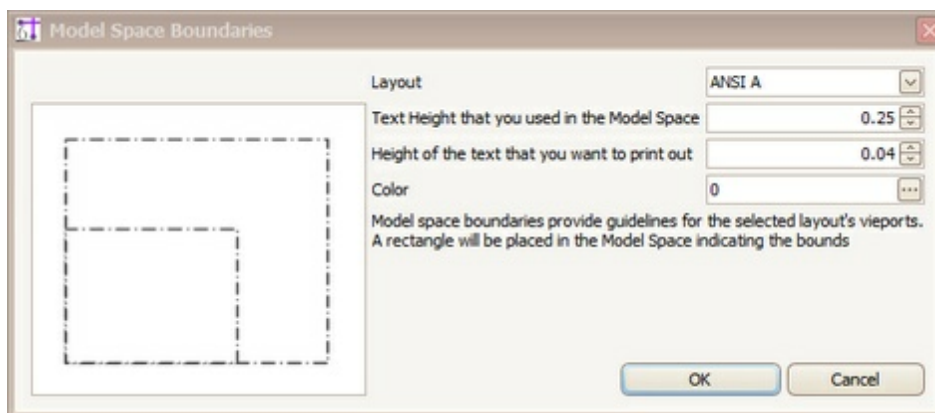

The Boundary dialog

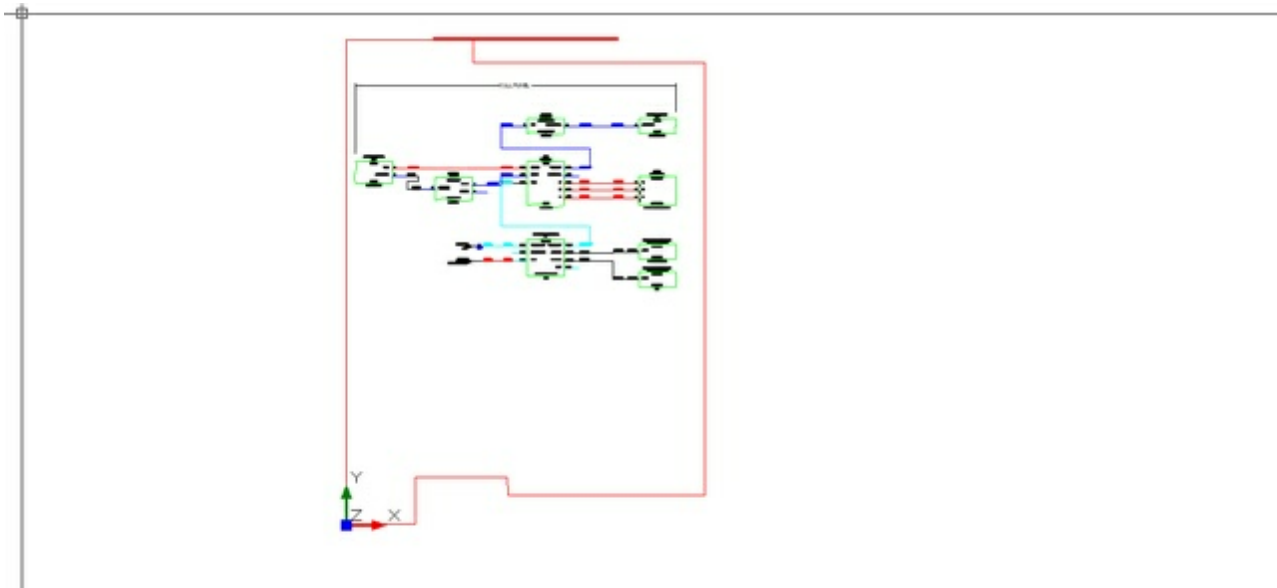

The boundary is created and positioned against the viewport from which it is created at the scale defined by our parameters

9.9 Grid

Description

The grid is a rectangular pattern of dots that extends over the area you specify as the drawing limits. Using the grid is similar to placing a sheet of grid paper under a drawing. The grid helps you align objects and visualize the distances between them.

The grid is not printed. If you zoom in or out of your drawing, you may need to adjust grid spacing to be more appropriate for the new magnification.

Remarks

User can modify the x,y grid spacing(distance between the dots horizontally or vertically).\

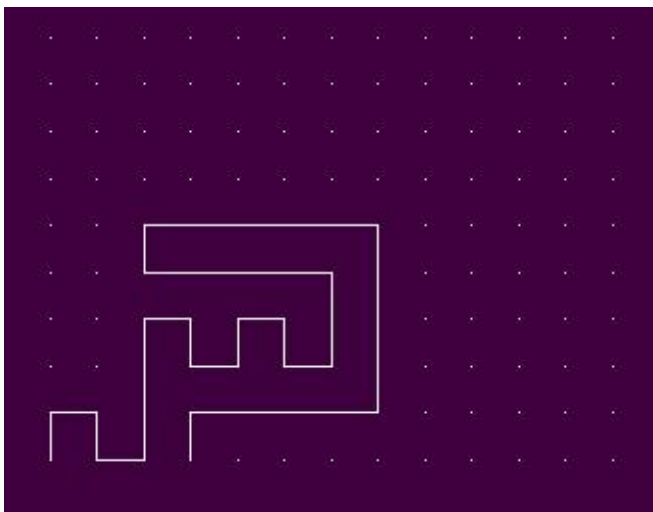

9.10 Snap

Description

Snap mode restricts the movement of the crosshairs to intervals that you define. When Snap mode is on, the cursor seems to adhere, or "snap," to an invisible rectangular grid. Snap is useful for specifying precise points with the arrow keys or the pointing device.

Remarks

User can modify the x,y snap spacing.

You can also set the base point of the snap. This point defines the bottom left point of the snap.

If you need to draw along a specific alignment or angle, you can change the snap angle. This rotation realigns the crosshairs on the screen to match the new angle.

9.11 Ortho

Description

A setting that limits pointing device input to horizontal or vertical (relative to the current snap angle and the user [coordinate](#) system).

That means that if ortho mode is on and you want to draw for example one line , this line will be parallel to x or y axis.

Remarks

9.12 Osnap

Description

An object snap(Osnap) mode specifies a snap point at an exact location on an object. osnap specifies running object snap modes, which remain active until you turn them off.

Remarks

The snap point on an object can be:

- Endpoint
- Midpoint
- Center
- Insertion
- Perpendicular
- Nearest
- Apparent Intersection
- Node (point)
- Quadrant
- Tangent
- Intersection (one point)

9.13 Units

Description

You can specify the type of the current unit of measurement and the precision for the current units as also the current angle format and the precision for the current angle display.

Remarks

Type of measurement can be:

Scientific	<i>1.6449E+001</i>
Decimal	<i>16.4492</i>
Engineering	<i>1' - 4.4492"</i>
Architectural	<i>1' - 4 7/16"</i>
Fractional	<i>16 7/16</i>

Windows desktop (It takes the settings of the regional settings)

Angle format can be:

- Decimal degrees
- Degrees/minutes/seconds
- Gradians
- Radians

9.14 Print

Description

By pressing the print preview button you can see the default Print Preview dialog of WireCAD.

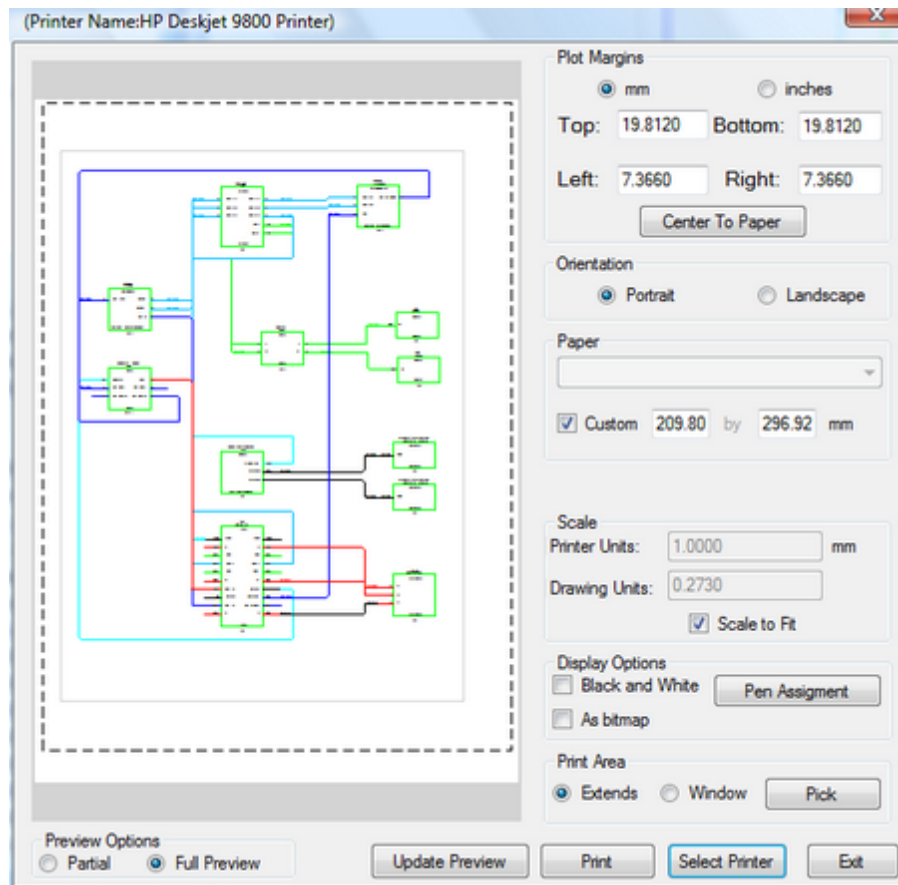

At the top right window you can set the margins either in millimeters or in inches.

Orientation can be change to landscape or portrait.

With Scale you can set the scale of the drawing in the print page. For example 1mm of the page will represent 0.35747 drawing units.

You can also turn B&W to on in order to print in black and white mode.

In print area you can either set extends to include the whole drawing or you can choose a window.

9.15 PDF Export

Description

By pressing the PDF Export button you can see the Print Preview dialog in PDF Export mode. Note the Print button has been replaced by a Save button.

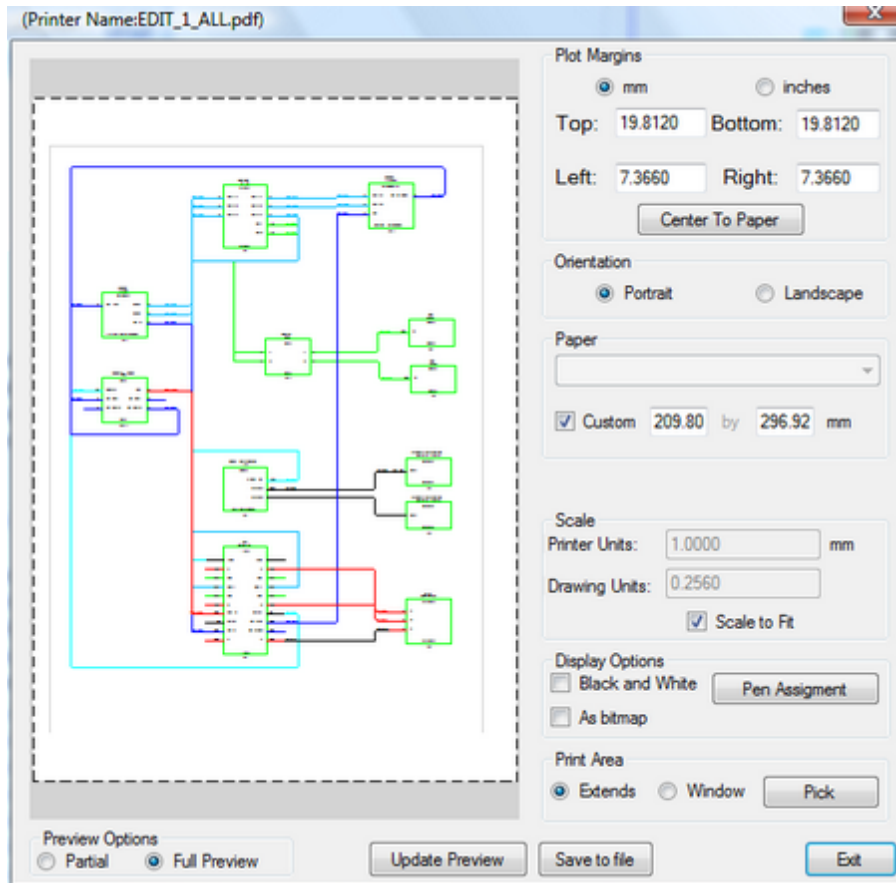

9.16 Extrusion Vector

Description

The extrusion vector defines the plane that the object will be drawn and is always vertical in that plane.

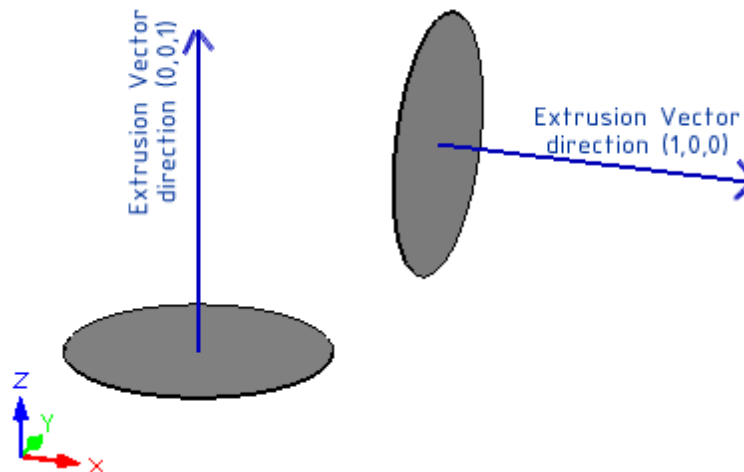

Remarks

If the entity has thickness then the thickness follows extrusion vector direction.

For example the default value of extrusion vector is (0,0,1) (the Z axis direction) if the object is drawn in the XY plane.

Part

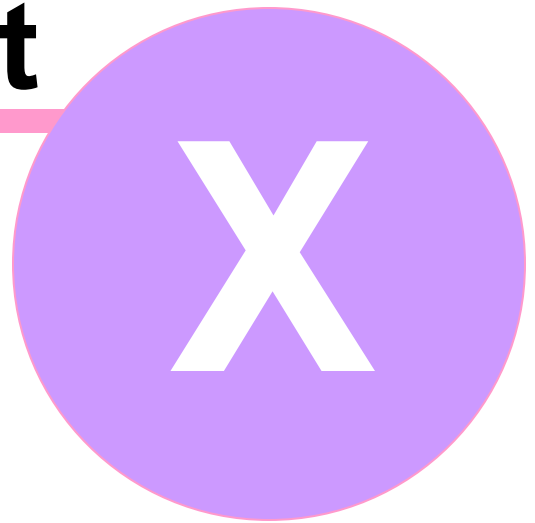

10 Customizing WireCAD (SDK)

WireCAD XLT and PRO provide access to the WireCAD Software Development Kit (SDK). With the WireCAD SDK you can write code to customize WireCAD to fit your needs. A complete discussion of the WireCAD SDK is beyond the scope of this manual. What follows is a brief outline of how easy it is to write WireCAD Plugins. The assumption is that you have a basic understanding of C# programming syntax and structure (the examples are in C# but you may use and .NET programming language that you are comfortable with). If you do not understand it don't let that deter you. It is really very easy to understand. Microsoft has tons of examples. Just get on the web.

STUDY THE EXAMPLES in the \WireCAD shared\WireCAD SDK\Examples folder

If you have WireCAD SDK specific questions post them on the forum along with as much code as you can and an explanation of what you are trying to do. We will try to help. If you need more help or if you are developing a commercial plugin for WireCAD you may want to consider purchasing SDK assurance. Please call the office for more information. Please note that we cannot take phone support calls for SDK issues unless you are an SDK assurance member.

The first place to go with any programming effort is the ubiquitous "Hello World" example in the Basic folder.

NOTE: there are two types of WireCAD plugin.

1. The automatically discovered (AD) plugin that loads silently and may or may not interact with the user.
2. Plugins that require a WireCAD .wpi manifest file that describes where the plugin can be found, how to call it, what icon to display and on which toolbar or menu, etc. Both plugins implement the WireCAD.IPlugin interface.

AD plugins are named YourPluginName.Plugin.Dll and are placed in the ..\WireCADx\bin folder. Standard WireCAD plugins have no naming requirements but must be accompanied by a .wpi file in the ..\WireCADx\bin\plugins folder.

To create a wpi file you can use the utility in Plugins>Plugin Manager [New PI Info]

Take some time to read through the code. The interface is very simple, yet you can access most of the WireCAD object model including drawing, data access, grids, GUI, reports, etc.

You can also create your own forms and functions to interact with the WireCAD objects.

```

////////////////////////////////////
THIRD PARTY LIBRARIES
////////////////////////////////////
WIRECAD USES THIRD PARTY LIBRARIES THAT MAY REQUIRE YOU TO PURCHASE DEVELOPER COPIES. PLEASE
DO NOT IGNORE THIS STATEMENT. THESE ARE GREAT LIBRARIES AND IF YOU ARE PLANNING TO DEVELOP A
COMMERCIAL PLUGIN FOR WIRECAD YOU WILL WANT TO HAVE THEM. If you are developing a small project or
line of business function for your own use you may not need to purchase licenses. Here is an example: If you want
your plugin to have the same look and feel, or create a custom form with the same gridview or treeview as
WireCAD you will need to purchase the Developer Express library. If you are developing a custom form that needs
to show its own drawing engine you will need to purchase the VectorDraw developer framework. If, on the other
hand, you are able to use the WireCAD baseforms object, are happy with the WinForms controls and can develop
using the WireCAD drawing engine then you can get started without spending a dime.

```

10.1 Hello World

Every programming effort starts with the ubiquitous "Hello World" example. This example is meant to provide just enough information to show the framework and produce an output.

Please note that in C# comments are preceded by `//`.

```

////////////////////////////////////
//WireCAD Plugin
//Contents:
//    Basic WireCAD Plugin Framework
//
//Instructions:
//    1.This project assumes that you installed WireCAD in the default
//       location. If you did not, you will need to change the reference
//       path and the build path to that of your install path
//       ..\WireCADx\bin folder. You can do that byclicking:
//       Project>Project Options [Reference Paths] Reference path
//       Project>Project Options [Compiling Tab] Output Path
//    3.Add your code and build
//    4.Create a wpi file (from within WireCAD click Plugins>Plugin Manager [New]) that points to your as
//       place it in the ..WireCADx\bin\plugins folder
//
////////////////////////////////////
//Explanation:
//This heloworld example demonstrates a number of different WireCAD SDK
//concepts. This is WireCAD Automatically Discovered (AD) plugin and
//therefore does not require a .wpi file in the /plugins folder. As such,
//it will load silently and can only be executed from the commandline since
//it does not add any other GUI elements.
//
//TESTING:
//First familiarize yourself with the code below and try to understand
//what will happen before testing.
//1. Build the project and ensure that the helloworld.plugin.dll is located
//    in the ..WireCADx\bin folder.
//2. if WireCAD is running click Plugins>Plugin Manager[Rescan and Load Plugins]
//3. Type hw into the WireCAD commandline.

using System;
using System.Collections.Generic;
using System.Linq;
using System.Text;
using System.Windows.Forms;

using VectorDraw.Professional.vdFigures;
using VectorDraw.Professional.vdObjects;
using WireCAD;
using WireCAD.Interfaces;
using WireCAD.Translation;

namespace hello_world
{
    public class MyPlugin: IPluginCore
    {
        #region Fields
            //Place your field level variables here
            CommandInfo ci = null;

```



```
#endregion

    #region Properties
    //Place your Properties Here

#endregion

#region IPluginCore Members

/// <summary>
/// Called before plugin is loaded to make sure that this plugin
/// has permission to run at this application mode level and
/// for this person(Identity)
/// </summary>
/// <param name="ws">The Singleton Workspace object</param>
/// <param name="id">Current user identity</param>
/// <returns>should return true if the plug can load</returns>
public bool HasPermissionToRun(IWorkspace ws, Identity id)
{
    return true;
}

/// <summary>
/// This is called when the plugin is loaded at application start
/// </summary>
/// <param name="ws">Singleton WireCAD Workspace object</param>
public void Load(IWorkspace ws)
{
    //We pass an IWorkspace object exposing most if the WireCAD
    //object model

    //on load we will register a commandInfo object with our
    //commands so that our static method can be invoked from
    //the command line in WireCAD
    ci = new CommandInfo();
    //The name of our dll
    ci.Assembly = "helloworld.plugin.dll";
    //The NameSpace and Class of our function
    ci.NameSpaceAndClass = "hello_world.MyPlugin";
    //Our function's name
    ci.MethodName = "HelloWorld";
    //The long descriptive name of our function
    ci.CommandLongName = "Hello World Demo";
    //An alternative name for our function. You can type this text into the WireCAD command line
    //to call the function
    ci.CommandAlt = "hello";
        //The shortcut
    ci.ShortCut = "hw";
    //this registers the command so that the commandline knows how to parse the information
    //and call our function
    ws.Commands.RegisterCommand(ci);
}

/// <summary>
/// Unload code for your plugin
/// </summary>
/// <param name="ws"></param>
public void Unload(IWorkspace ws)
{

```

```
//here we place any code to unload our plugin.

//Unregistering the commandInfo prohibits the command from
//being persisted. This is more a development function.
//once you are ready to distribute your plugin you will
//probably want your user to be able to save his own shortcuts
//and therefore not unregister the command.
ws.Commands.UnRegisterCommand(ci);
}

#endregion

#region Static Methods
/// <summary>
/// Static method that can be called from the WireCAD command line
/// It's a good idea to rename this to something meaningful
/// </summary>
/// <param name="ws">WireCAD is expecting to find this parameter</param>
public static void HelloWorld(Workspace ws)
{
    //This hello world function demonstrates a number of different
    //areas of the WireCAD SDK

    //this is a winForms messagebox
    MessageBox.Show("Hello World");

    //now we'll show an instance of form1(defined elsewhere in this project);
    Form1 f = new Form1();
    f.ShowDialog();

    //now let's send a message to the Command Line History
    ws.MainForm.CommandLine.AppendHistory("Hello World");

    //let's check to make sure that we have an open drawing
    if(!Commands.IsActiveDrawing(ws,true))
    {
        //no active drawing so return
        return;
    }

    //Get some user input on the next step
    if(DialogResult.No == MessageBox.Show(
        "Would you like us to add some text to the active drawing?",
        "WireCAD SDK",MessageBoxButtons.YesNo)) return;

    //First we create a vdText object
    vdText text = new vdText();
    //register it with the active document
    text.SetUnRegisterDocument(ws.ActiveDrawing);
    //give it the document defaults
    text.setDocumentDefaults();
    //Set the string
    text.TextString = "hello world";
    //locate it in the coordinate space
    text.InsertionPoint = new VectorDraw.Geometry.gPoint(0,0,0);
    //Set the textHeight
    text.Height = .25;
    //Set the color
    vdColor colorRed = new vdColor();
    colorRed.SetUnRegisterDocument(ws.ActiveDrawing);
    colorRed.Palette = ws.ActiveDrawing.Palette;
```

```

colorRed.FromRGB(255,0,0);

text.PenColor = colorRed;

//alternately you could do this
//text.PenColor.ColorIndex = 1;

//our text will be added to the drawing on the ActiveLayer and with
//the ActiveTextStyle if you want to change those you can by setting
//those properties on the text object

ws.ActiveDrawing.ActiveLayOut.Entities.AddItem(text);

//now refresh the drawing
ws.ActiveDrawing.Redraw(true);
    //alternately you can just invalidate the text object(less expensive)
    //like this:
    //text.Invalidate();
}

#endregion
}
}

```

10.2 Getting Started

Menu: **Plugins>Plugin Manager[Edit Plugin Code]**

Applies To:
XLT PRO
Related Settings:
None

Default command line shortcut: **none**

To get started writing plugins for WireCAD launch the #Develop (pronounced sharp develop) development environment.

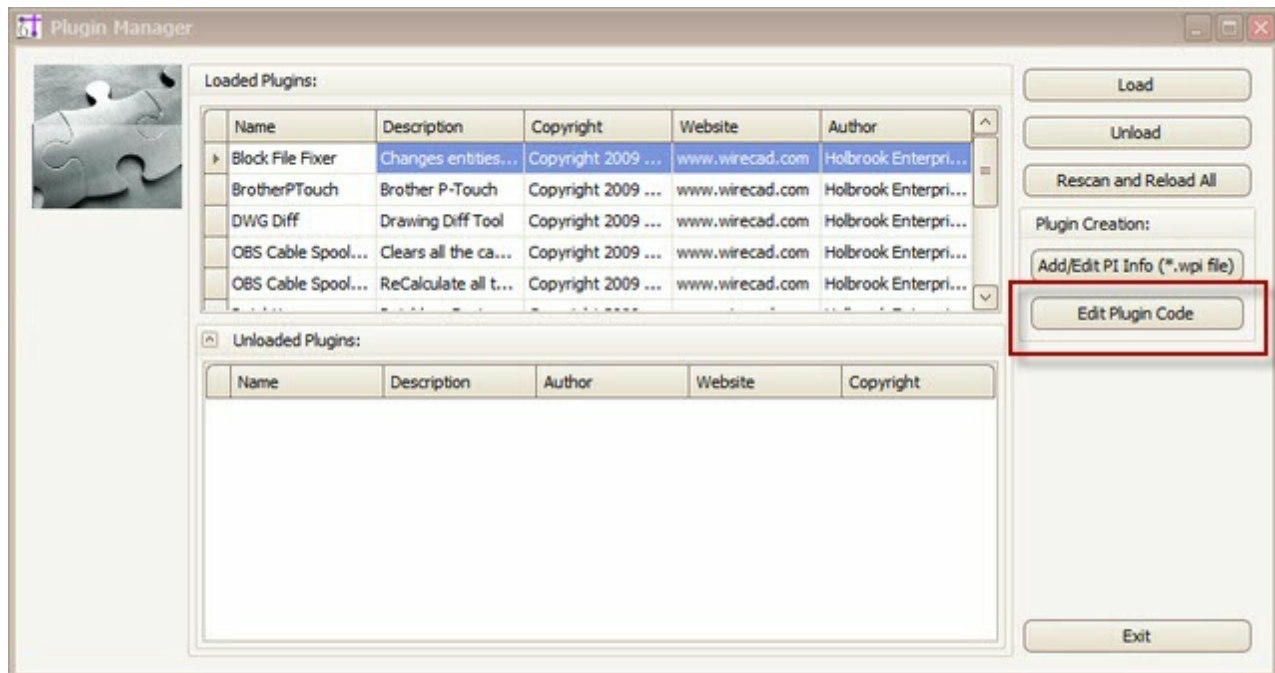

Click

File>New>Solution

Select WireCAD Plugin and enter a Name and solution path

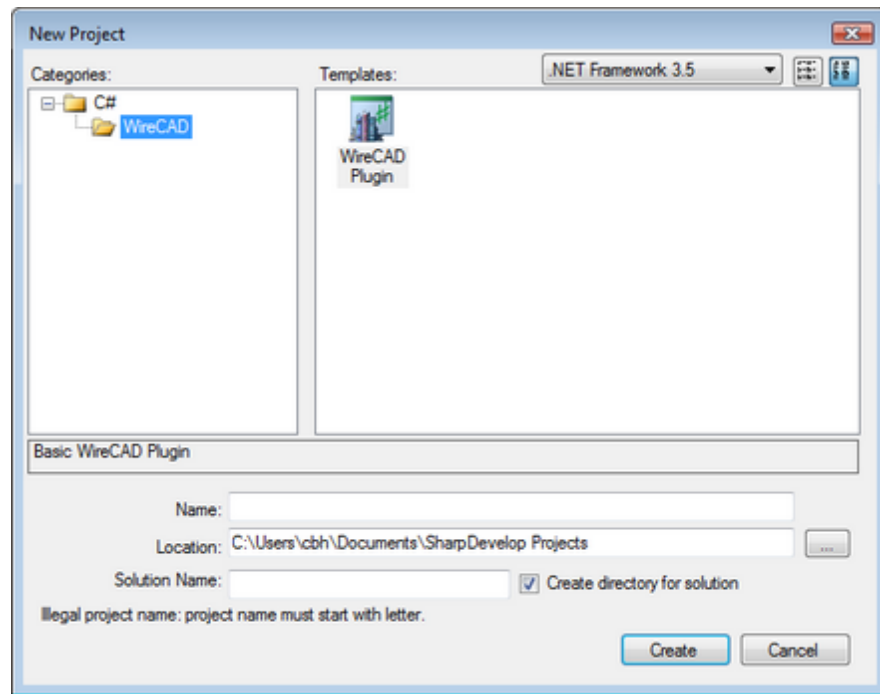

Click **[Create]** and a new solution will be created for you with all the necessary references and interface files. Now start coding!

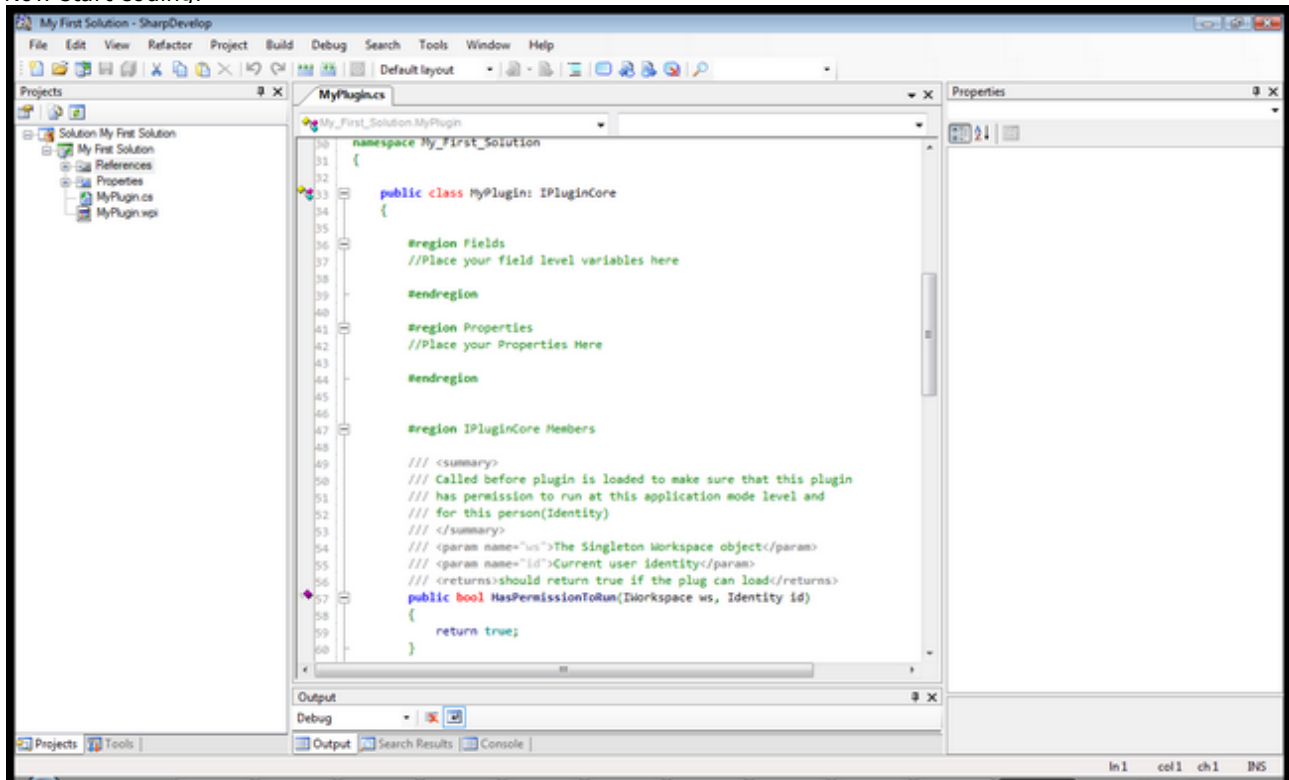

To test your plugin make sure that is copied to the WireCAD\bin folder and that your [.wpi](#) manifest file is in the WireCAD\Bin\Plugins folder.

Relaunch WireCAD or click **[Rescan and Reload]** from the WireCAD Plugin Manager to make WireCAD load your plugin

Debugging Your Code

To debug you will attach the #Develop debugger to the main WireCAD process by clicking **Debug>Attach to Process** and select WireCAD from the list of running processes. You can place breakpoints by clicking on the left edge of the edit space.

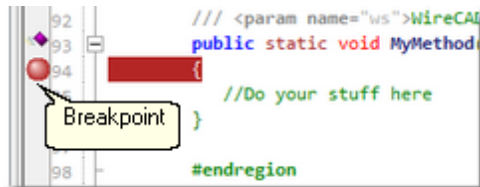

When code is executing with the debugger attached and the breakpoint is hit code will stop executing and allow you to examine variables. To continue execution use the Continue, or Step functions.

Happy coding!

10.3 Registering Your Plugin

Menu: **Plugins>Plugin Manager[Add/Edit PI Info]**

Applies To:
XLT PRO
Related Settings:
None

Default command line shortcut: **none**

Assuming your plugin requires user input to launch it, ie it does not respond to an event. You will want to register your command with the application.

WireCAD uses an information file (wpi - WireCAD Plugin Info) to describe a command and to tell the application how to execute the command. WireCAD looks for these files in the c:\program files\WireCAD\bin\plugins folder.

Commands can be executed directly from the commandline or from a button on a menu bar. In order to register your command you must, at minimum, set up the commandline arguments. Toolbar buttons are optional. To edit a wpi file use the editor.

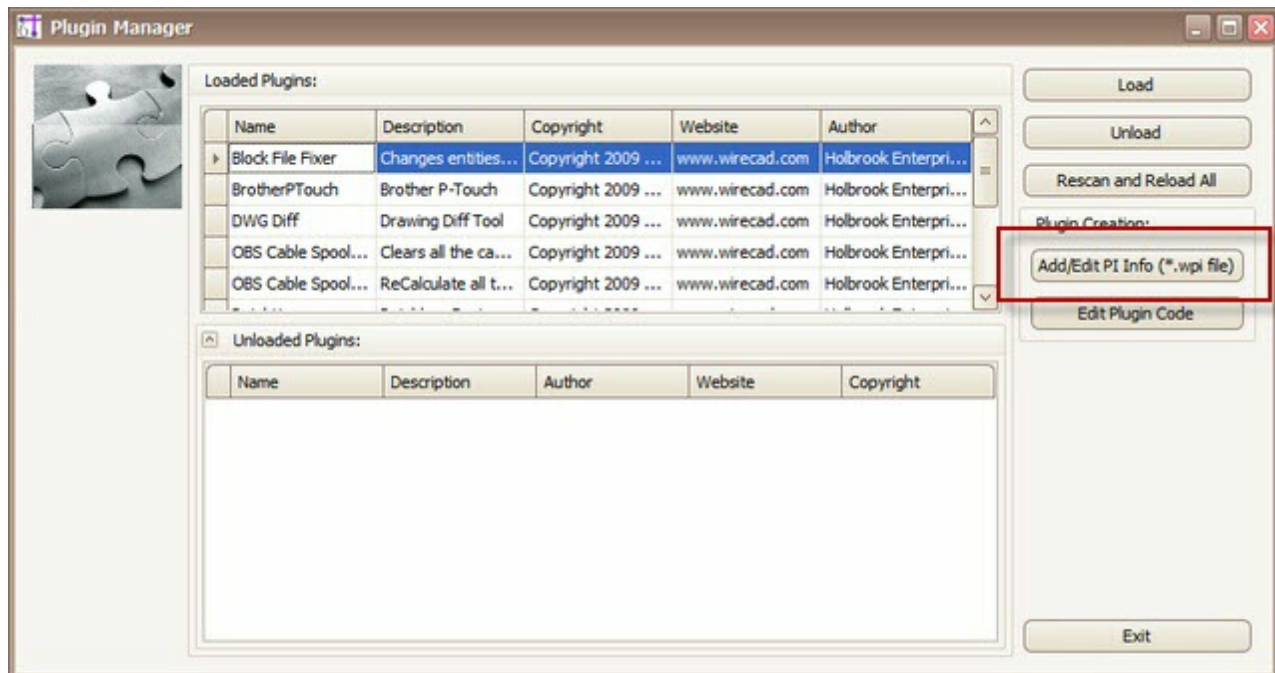

WPI File Editor

Name
Description
Author Self explanatory
Website
Copyright

Button Info

Tool Tip Tool tip text
Caption The button caption
Button Site What is the base location of the button
Button Path Button path is the path in the menu tree of the button. Start with Main Menu and work your way down. If the menu tree does not exist it will be created. Use the & key to create accelerators. If you are using an existing path be sure to include accelerators or you will end up creating a new menu item.
Button Bitmap 16x16 bitmap

Command Line and Assembly Info

Long Name The display name of your command
Short Name The shortcut
Alt Shorter less descriptive
Assembly Name The name and path of your dll. If no path we will search the WireCAD\bin directory
Namespace Dot Class SomeNameSpace.MyClass where your function is located
Static Method Name The static void method name of your function. This must have the proper signature as follows:

```
public static void YourFunctionName(WorkSpace ws)
{
    .....
}
```

Using the above example the Static Method Name would be: YourFunctionName

NOTE: if you use the WireCAD Plugin [template](#)^[16] a static method with the proper signature will be created for you.

A Note About the Index

The following index is generated from the online text and as such the page numbers may represent a sub chapter heading instead of the actual page.

The key word you are searching for will be in the sub chapter.

Index

- % -

%BLOCKS% 50
%DOCUMENTS% 50
%ICONS% 50
%IMAGES% 50

- [-

[Cleanup] 47
[Clear All Cables] 47
[Fillet] 47
[Preview] 65
[Ratsnest] 47

- 3 -

3DFace 129

- A -

ACID Compliant 97
Activation 7
Add All Cores 38
Add Equipment to Drawings 20
Add Ports 20
Alias 36, 116
Application Settings Panel 50
Apply Filter 111
Arc 125
Array 142
assign multiple terminals 39
Assign Terminals 40
Attribute Height 41
Authorization 7
AutoScheme 45
Aux Text 28
Available 115
Available Cable Number Variables 83
Available SysName Variables 80
AvailableCores 115
Avoid Other Cables 47

- B -

BlockRef 41
Blocks 134
Break 143

- C -

Cable Number Fields 115
Cable Router X Offset 29, 30
Cable Terminology 25
CableID 115
CableNo 38, 115
CableNoPrefix 115
CableNoSuffix 115
CableType 38, 115
CableTypeManu 38, 115
Chain Print 112
Chassis Width 41
Circle 121
Circuit Recursion 47
CktDst 115
CktID 115
CktNo 38, 115
CktSrc 115
Cleanup 45
Clear Filter 111
Collections 130
Commands 137
Community Library Auto-Contribute Mode 50
Conflict 116
Coordinates 146
Copies 112
Copy 139
Create Model Space Boundaries 23
CreatedBy 115
CreateFromDimensions 41
CreateFromDimensionsIfNotFound 41
CurrentProjectRevision 116
Customizing WireCAD 156
Cut Mark 112

- D -

data grid 111
Data Page 111

Database Field Rules 114
 Database Format 97
 DateAdded 116
 DateModified 115, 116
 DateOriginated 115
 Default Pointer 30
 Demystifying Synchronization 92
 DestConn 115
 Destination 38
 DestLoc 115
 Destpin 115
 DestSys 115
 Dimension 125
 DimStyles 133
 Display As 46
 Display Preferences 46
 Distance 47
 Draw Cable Toolbar 24
 Draw Cables Toolbar 25
 Drawing Cables 24
 Drawing Objects 120
 Drawing Settings Panel 56
 DstAlias 115

- E -

Edit 112
 Elevation 116
 Ellipse 127
 Engineering Data tab 36
 EquipmentName 116
 Erase 138
 Explode 144
 Extend 141
 Extrusion Vector 153

- F -

Feeder Selection 31
 Fill Gaps 36
 Fillet 140
 Flags 36
 Floating License Lease 6
 Floating Licenses 6

- G -

Get Port Data From Cables Database 46
 Getting Started 160
 Grid 149

- H -

Half Cut 112
 Height in RU 41
 Hello World 157
 Horizontal Spacing DU 46
 How Rack Builder Works 42
 How SysName Formatting Works 79
 How SysName Formattion Works 82
 How to Place Custom Titleblocks into Your Drawing 86
 How To: Add Equipment to Drawings 20
 How To: Add Equipment to the Library 19
 How To: Create a new drawing using the wizard 23
 How To: Create a New Project 22
 How To: Create Your Own Custom Titleblocks 87

- I -

Image 126
 Include hashes 41
 Inputs 39
 Insert 129
 Insertion Point 41, 46
 Integrator 115
 Introduction 110
 IsSequential 36
 IsSequential 116

- L -

Label Report 72
 Layers 130
 Layouts 132
 Length 115
 License Agreement 9
 Licensing FAQ 11
 Lights 135
 Limits 146
 Line 120

Linetypes 136
Lineweights 137
Location 116
location change 41
Location Filter 46

- M -

Manual Draw Cables 27
Manufacturer 116
Many-to-Many Cable 33
Many-to-One Cable 32
Maximum Column Count 46
minimum WireCAD build version 110
Mirror 142
Mirroring 112
More about Regular Expressions 81, 84
Move 141
Multicore 38, 115

- N -

NamedPath 115
New + 38
New Drawing 23
New Drawing Wizard 55
New Equipment 19
New Plugin Template 161
New Project 22
New Report with Wizard 68

- O -

Offset 139
One-to-Many Cable 30
One-to-One Cable 24, 26
Ortho 150
Osnap 150
Outputs 39
Outputs track inputs 39

- P -

Pan 145
parameters 65
Persist this equipment 39
Pinouts 101

Place Text If Item Cannot Be Created 41
Polyface 127
PolyHatch 127
Polyline 122
Port Polling Status Bar 55
Preview 65, 112
Print 151
Print All 112
Print Cable Labels and Port Tags 112
Print This 112
Printer Options 112
PRO 5
Project Cables database 111
Project Settings Panel 58
Project Systems database 111
Project>Utilities>Pack Up/Check Out 97
ProjectRevision 115
P-touch 110
Purge 144

- R -

Rack Builder Controls 43
Rack Builder tool 41
RatsNest 45
Record Selectors 112
ReplacedBY 115
Report filtering 66
Reports 65

- S -

Scale 143
Section Clips 135
Select 138
Selected Format 79
Selections 135
SHEET 115
Show Cable Numbers 47
ShowDWGInPath 41
Signal Types to Display 46
SignalType 38, 115
Slot Count 41
Slot Delimiter 41
Snap 150
Software Activation 5
Software Key 7

Sort I/O By Last Display Order 47
Source 38
Spacing DU 41
SRCALias 115
SrcConn 115
SrcLoc 115
SrcPin 115
SrcSys 115
Submit 65
Support Paths 52
SysName 36, 39, 41, 116
SysName Format Controls 80, 82
SysNum 116
System Snapshot 47
Systems Involved 41

- T -

Table 111
Template File 112
Terminal 47
Terminal as a Destination Cable 35
Terminal as a Source Cable 34
Text 128
TextStyles 133
Trim 141
Troubleshooting Activation 8

- U -

Undo 139
Units 151
Unlock 38
Use New Drawing Wizard 55
User Data tab 36
User Settings Panel 54
User1 115, 116
User2 115, 116
User3 115, 116
User4 115, 116

- V -

Variable List 79
View Rule 41
View3D 145
Viewport 147

- W -

What is CAD ? 119
WireCAD Security 50
Work Flow Diagram 14

- X -

XL FREE 5
XLT 5

- Z -

Zero Administration 97
Zoom 144

